

Smart Dupline® Temperature Controller Type SHE5XTEMDIS

CARLO GAVAZZI



- Smart-house temperature controller with display
- Developed to fit into wall socket from Elko, Gira and Jung
- Shows current room temperature, floor temperature and shows outdoor temperature
- Turns on/off heating and cooling
- Sets wanted room/floor temperature
- Energy Saving through 3 heating setpoints and 3 cooling setpoints
- Delivered with 2 white and 1 black pushbutton covers
- White LEDs: programmable guide light function
- Blue LEDs: programmable function status

Product Description

SHE5XTEMDIS is a temperature display with 4 buttons and 4 LEDs. It is developed to be mounted into a 55x55 wall socket from Elko, Gira and Jung. The TEMDIS display can manage 6 automatic setpoints (3 for heat-

ing and 3 for cooling) and one manual setpoint to let the user manage in the most comfortable way the temperature in his home. The TEMDIS is part of the smart-house concept for building automation applications.

Ordering Key

SH E 5X TEMDIS

Smart-house _____
Eunica line _____
Housing 55 x 55 mm _____
Temperature display _____

Type Selection

Housing	Colour	LEDs	Supply by bus
55 x 55 mm	White/Black *	4 white / 4 blue	SHE5XTEMDIS

*Delivered with white and black pushbutton covers

Input Specifications

Sensor	1 integrated temperature sensor
Range	-10 - +50°C (32 - 122°F)
Accuracy	± 1°C
Floor sensor (not included)	
Temperature range	-10 - +50°C (32 - 122°F)
Cable length	4 m
Cable consists of 4 wires:	
Brown	Connect to “+” on Temperature controller
White	Connect to “C” on Temperature controller
Yellow	Connect to “d” on Temperature controller
Green	Connect to “⊥” on Temperature controller
	See wiring diagram

The floor sensor is an active 4-wire sensor and must be ordered separately: the part number is BSO-TEMDIG.

Output Specifications

LEDs	4 white / 4 blue
-------------	------------------

Dupline® Specifications

Voltage	8.2 V
Maximum Dupline® voltage	10 V
Minimum Dupline® voltage	4.5 V
Maximum Dupline® current	5 to 8 mA

Supply Specifications

Power supply	Supplied by Dupline® bus
Consumption	max 2 mA

General Specifications

Channel coding	The address assignment is automatic: the controller recognises the module through the SIN (Specific Identification Number) that has to be fitted in the Sx Tool.	Weight	50 g
Environment	Degree of protection Pollution degree Operating temperature Storage temperature Humidity (non-condensing)	Approvals	cULus, according to UL60950
Connection	Screwless detachable D+ D-	UL notes:	Max room temperature: 40°C
Housing	Back part dimensions Back part + front dimensions Back part material Push button covers Plastic clear	CE Marking	Yes
	IP 20 3 (IEC 60664) -10° to +50°C (14° to 122°F) -20° to +70°C (-4° to 158°F) 20 to 80% RH	EMC	
	0.2 to 1.5 m ² Signal GND	Immunity	EN 61000-6-2 EN 61000-4-2 EN 61000-4-3 EN 61000-4-4 EN 61000-4-5 EN 61000-4-6
	55 x 55 x 24 mm 55 x 55 x 28,4 mm Plastic, transparent Plastic, white (RAL 9010) white (RAL 9016) Plastic, black	- Electrostatic discharge - Radiated radiofrequency - Burst immunity - Surge - Conducted radio frequency - Power frequency magnetic fields - Voltage dips, variations, interruptions Emission	EN 61000-4-8 EN 61000-4-11 EN 61000-6-3
		- Conducted and radiated emissions - Conducted emissions - Radiated emissions	CISPR 22 (EN55022), cl. B CISPR 16-2-1 (EN55016-2-1) CISPR 16-2-3 (EN55016-2-3)

Mode of Operation

Symbol description:

On the display the following five symbols are used:

 Temperature symbol 1, indicates that the regulating temperature is currently shown on the display.

 Temperature symbol 2: steady, indicates that the second probe is shown (floor if the TEMDIS is regulating according to room temperature, or room probe if TEMDIS is regulating according to floor temperature). Flashing indicates the external probe if configured.

 Heat symbol, indicating that a heat application is currently selected. When the symbol is blinking, the unit is heating. When the symbol is steady, Heat mode is selected.

 Frost symbol, indicating that a cooling application is currently selected. When the symbol is blinking, the unit is cooling. When the symbol is steady, Cooling mode is selected.

 T1 symbol, indicating that the current application is regulated according to setpoint1.

 T2 symbol, indicating that the current application is regulated according to setpoint2.

 T3 symbol, indicating that the current application is regulated according to setpoint3.





 Hand symbol, indicating that the current application is regulated according to a manual setpoint

 The temperature is shown in degrees Celsius.

 The temperature is shown in degrees Fahrenheit.

Starting Up

When the temperature controller is connected to the smart-house bus, the display digits will start flashing. The display will continue to flash until a complete status has been received from the smart-house controller. This will take approximately 1 min. When the temperature controller has received a complete status, the display will stop flashing and will show the current application status and room or floor temperature.

Button	Name	Description
	HOME	Shows the different probes and enters hand mode
	ENTER	Shows clock and enters setpoint modification status
	DOWN	Enters adjust cooling temperature setpoint
	UP	Enters adjust heating temperature setpoint

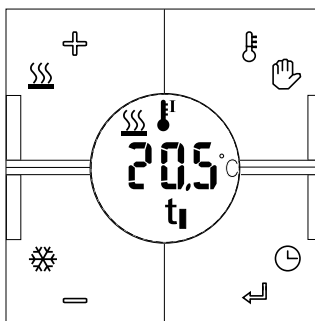

Function Description

After the start-up has finished, normal operation will begin. The user has the following options.







Temperature option ⁽¹⁾

When the HOME key () is pressed briefly, the current floor temperature is shown (or room temperature if the system is regulated

according to the floor temperature) for 10 seconds and the symbol  (not flashing) will be displayed. If the HOME key is pressed again within 10 seconds, the external temperature is displayed (symbol  flashing). If it is pressed again within 10 seconds it returns to the probe control. If the floor probe or the external probe are not connected, the display will show ---.

Heating setpoints visualization ⁽¹⁾

By pressing the UP key () briefly, the current heating setpoint is shown. If pressed again within the 10 seconds the other heating setpoints (T1, T2, T3, OFF) are displayed with the relevant symbols , , .

Mode of Operation

If no keys are pressed, after 10 seconds the display will show again the current probe value.

Selecting a different heating setpoint

Once the required setpoint is selected using the UP key, press the ENTER key (↵) to confirm it.

Cooling setpoints visualization ⁽¹⁾

By pressing the DOWN key (⏴) briefly, the current cooling setpoint is shown. If pressed again within 10 seconds the other cooling setpoints (T1, T2, T3, OFF) are displayed with the relevant symbols t_1 , t_2 , t_3 . If no keys are pressed, after 10 seconds the display will show again the current probe value.

Selecting a different cooling setpoint

Once the required setpoint is selected using the DOWN key, press the ENTER key (↵) to confirm it.

Entering hand mode ⁽¹⁾

When the HOME key (🏠) is kept pressed for 3 seconds, you enter the hand mode and a manual setpoint can be chosen: the hand symbol (👤) will be shown. To exit from the hand mode, keep the HOME key pressed for 3 seconds. In the hand mode, if the UP or DOWN keys are pressed, only the manual set is displayed and you do not access the three automatic sets.

Changing the value of a setpoint

From the setpoint visualization, whether manually or automatically, if the ENTER key is kept pressed for 3 seconds, the setpoint value will start flashing: with the UP and DOWN keys it is possible to modify the setpoint in steps of 0.5°C. By keeping pressed the UP and DOWN keys you have double speed. To confirm, press the ENTER key: the setpoint value will be modified.

Entering the Temporary Mode ⁽¹⁾

Once the required setpoint is selected, press the ENTER key to activate the Temporary Mode temperature control according to the selected setpoint; after this change, the main page and the hand symbol will flash to indicate that the Temporary Mode has been chosen.

Exiting from the Temporary Mode

When the main page is shown, press and hold the UP or DOWN key for 3 seconds to exit from Temporary Mode and return to normal operation mode.

Automatic exit from the Temporary Mode ⁽¹⁾

This setpoint remains active until the expiry time at midnight.

Time clock visualization

If the ENTER key is pressed briefly in the home status (when the value of the current probe is shown), the clock is displayed. You should return to the display of the probe for timeout (10 seconds) or after having pressed "ENTER" briefly. The ENTER key pressed briefly in any other status functions only confirms and does not display the hour.

Deadband ⁽¹⁾

If deadband is used, TEMDIS shows the setpoints with no deadband, but regulates the temperature according to (setpoint-deadband) for heating, (setpoint+deadband) for cooling.

Addressing

If the light switch module is connected to the Sx2WEB24 controller, no addressing is needed since the module is provided with a specific identification number (SIN): the user only needs to insert the SIN number in the Sx Tool when creating the system configuration.

LED programming

The LEDs are also configurable via the Sx Tool:

- White LEDs: The 4 white LEDs can be individually programmed as guide lights: they will always be ON.
- Blue LEDs: The 4 blue LEDs will be ON when the relevant push-button is pressed.

Furthermore they can be programmed to blink when the regulating probe is faulty.

Wall Socket and frame compatible with the Eunica line

The Eunica 55x55 light switch can fit into the frames and wall sockets listed below: for any other model not included here below, CG does not guarantee any compatibility.

- Elko
- Gira
- Jung

⁽¹⁾ If programmed by software.

Dimensions

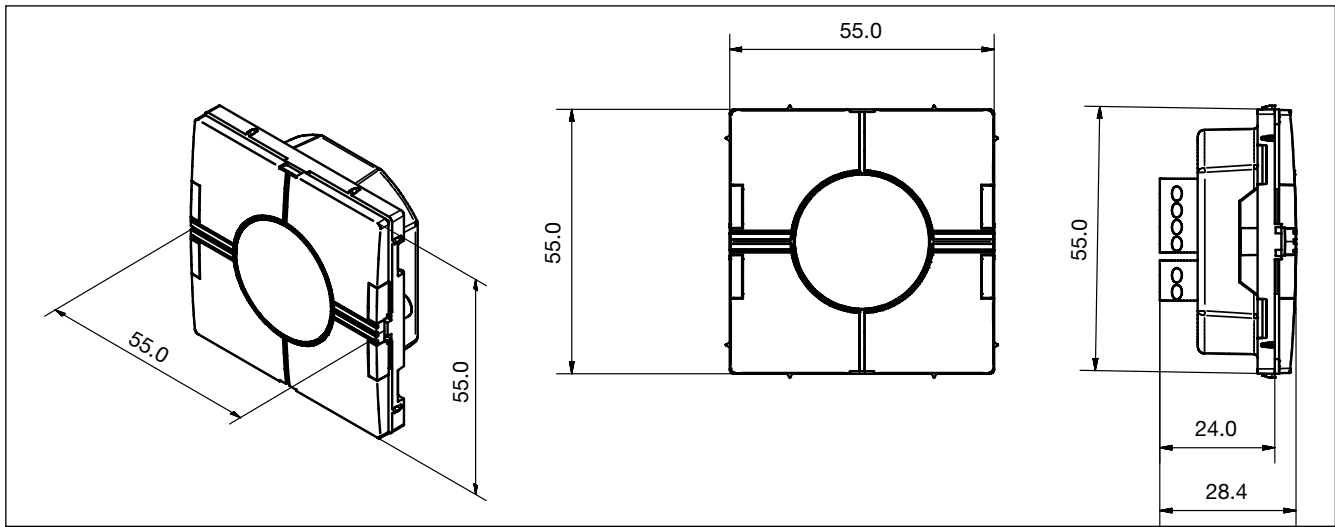

Wiring diagram

