

Photoelectrics Level Sensors Types VP, Modulated, Metal Housing

CARLO GAVAZZI



- Modulated light
- Built-in amplifier
- Output: NPN or PNP, 4-wire (NO & NC)
- Housing: Stainless steel or nickel plated brass
- Tip: Polysulphone or glass
- High chemical resistance to most acids and bases
- Liquid and electrical circuit completely isolated
- Power supply: DC models 10 to 40 VDC



Product Description

Optical level probe with modulated infrared light for detection of liquids. Self-contained unit has built-in amplifier. Separate transmitting and receiving elements

sealed behind the tip. Designed for direct mounting through the wall of a tank. The polysulphone tip is especially resistant to most acids and bases.

Ordering Key

VPB1 M NA-1

Type: Refraction principle	VPB1
Housing material	M
Tip material	NA
Light source	-
Output type	-
Connection	-1

Type Selection

Housing material	Tip material	Ordering no. NPN, Make & Break switching Cable	Ordering no. NPN, Make & Break switching M12 Plug	Ordering no. PNP, Make & Break switching Cable	Ordering no. PNP, Make & Break switching M12 Plug
Stainless steel	Polysulphone	VPA1MNA	VPA1MNA-1	VPA1MPA	VPA1MPA-1
Stainless steel	Glass	VPA2MNA	VPA2MNA-1	VPA2MPA	VPA2MPA-1
Nickel plated brass	Polysulphone	VPB1MNA	VPB1MNA-1	VPB1MPA	VPB1MPA-1
Nickel plated brass	Glass	VPB2MNA	VPB2MNA-1	VPB2MPA	VPB2MPA-1

Specifications

Rated operational voltage	10 - 40 VDC	Pressure	≤ 10 bar at +60°C (+ 140°F)
Ripple	≤ 10 V	Environment	
Output current		Degree of protection	IP 67
Continuous	≤ 200 mA	Operating temperature	-20° to +70°C (-4° to +158°F)
No-load supply current	≤ 7 mA	Storage temperature	-40° to +100°C (-40° to +212°F)
Voltage drop	≤ 2.5 VDC	Liquid temperature	+100°C (+212°F) for ≤ 60 s
Protection	Reverse polarity, short circuit, transients	Housing material	Stainless steel AISI 303 or nickel plated brass
Ambient light	≤ 50.000 lux	Cable	2 m, 4 x 0.3 mm ² , grey, Ø 5.2 oil resistant PVC
Transient voltage	1 kV	Resistance	≤ 100 Ω, extension possible
Delay after power-on	20 ms	Weight	90 g
Operating frequency	≤ 30 Hz	Tightening torque	
Indication for Output ON	LED, yellow No LED indication on plug types	Stainless steel	30 Nm
Sensing accuracy		Nickel plated brass	30 Nm
Liquid level difference	Horizontal mounting: ± 5 mm Vertical mounting: ± 2.5 mm	External thread	3/8" (ISO 228/1)
LED indication on plug types		CE-marking	Yes

Mode of Operation

The probe contains IR transmitter, receiver and amplifier with open collector NPN or PNP output. The light source is a Ga-As diode emitting modulated, infrared light in short pulses.

This level probe is thus insensitive to ambient light (up to 50,000 lux) and suitable even for adhesive liquids.

The conical tip of the sensor forms an angle of 90°. This angle acts as a prism, i.e. the beam, emitted from the Ga-As diode placed in one

side of the sensor head, is reflected internally to the phototransistor placed in the other side of the sensor head (fig. 1), provided that the tip of the sensor is situated in free air. If the sensor tip is immersed in a liquid, always having a refractive index different from air (fig. 2), the beam will be refracted into the liquid.

All types of sensors can operate in oil, waste water, aqueous solutions such as beer, wine, alcohol etc. without any kind of accessory.

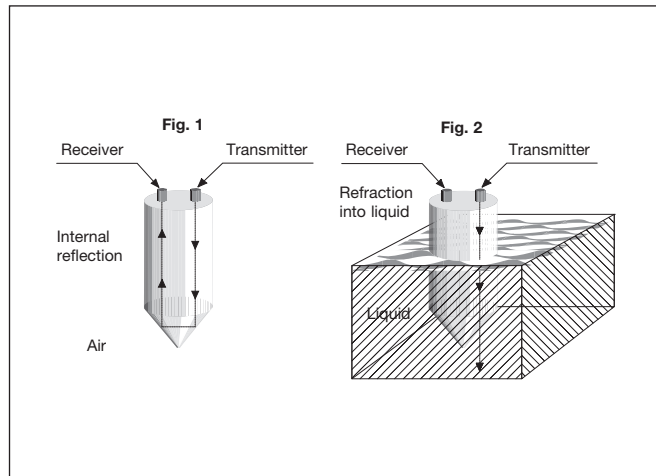

Dimensions

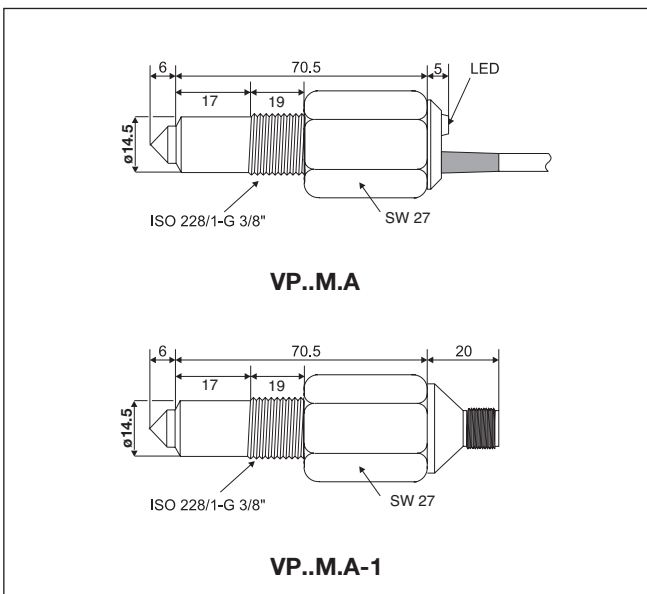

Wiring Diagrams

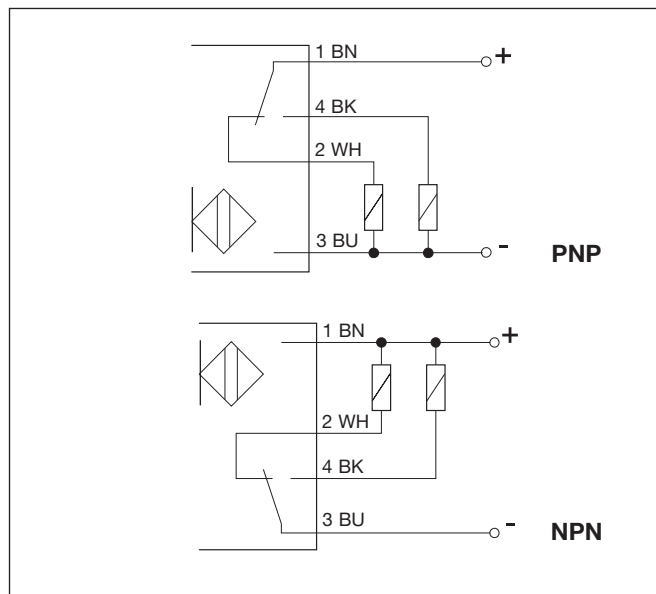

Installation Hints

<p>To avoid interference from inductive voltage/current peaks, separate the prox. switch power cables from any other power cables, e.g. motor, contactor or solenoid cables</p>	<p>Relief of cable strain</p> <p>The cable should not be pulled</p>	<p>Protection of the sensing face</p> <p>A proximity switch should not serve as mechanical stop</p>	<p>Switch mounted on mobile carrier</p> <p>Any repetitive flexing of the cable should be avoided</p>
---	---	---	--

Accessories

- Connector type CON.1A-../CON.14NF.. or CON.10-../CON.13NF series.