

Photoelectrics Amplifier, μ -Processor Controlled Type PAM, 2 - 10 Inputs/2 - 10 Transistor Outputs

CARLO GAVAZZI

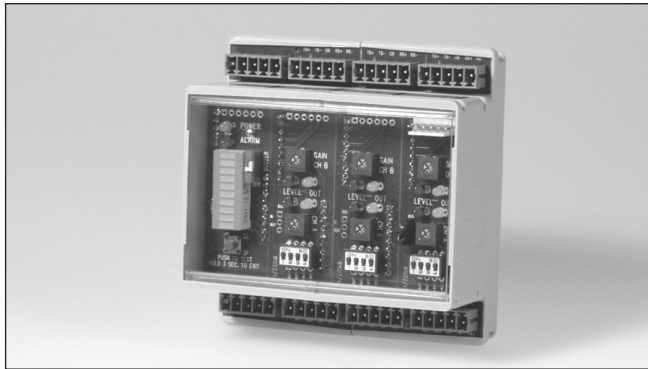

- μ -Processor controlled
- Amplifier unit for up to 10 sets of photoelectric sensors
- Up to 10 independent outputs
- Self-diagnostic functions
- Level/Alignment failure indication
- Inputs for external test/setting functions
- Multivoltage 18 to 33 VDC
- Automatic and manual regulation of emitter power
- Alignment output 0 to 10 V
- Bargraph and sound (buzzer) alignment indication
- Multiplexed to avoid crosstalk
- LED indications: supply, outputs, signal quality, alarm



Product Description

Flexible micro-processor controlled amplifier consisting of a basic module and 1, 2 or 3 sensor modules with 2 channels each and an expansion kit, giving the possibility to connect from 2 to 10 sets of photoelectric sensors, type MOFTR. The amplifier is in a DIN-rail mountable closed housing with quick disconnect terminals. Each channel has an independent transistor output NPN, PNP NO (make switching) or NC (break switching). Selfdiagnostics and

alignment aid together with alarm output are features that facilitate the installation and daily use of the system. Outputs, transmitter and receiver inputs are protected against short-circuit and reverse wiring. The light is modulated and synchronized for high ambient light immunity, and the channels are multiplexed for avoiding crosstalk. An additional module is available with relay outputs for 6 channels.

Ordering Key

PAM06AN3ANOxxxx

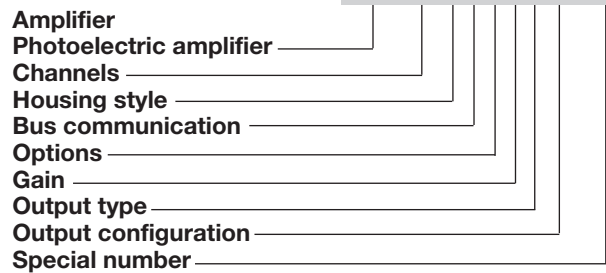

Type Selection Amplifier

| Housing W x H x D (mm) | Number of channels | Ordering no. NPN output Make switching (NO) | Ordering no. NPN output Brake switching (NC) | Ordering no. PNP output Make switching (NO) | Ordering no. PNP output Brake switching (NC) |
|------------------------------|--------------------------|---|--|---|--|
| 48 x 96 x 55 | 2 | PAM02AN3ANO | PAM02AN3ANC | PAM02AN3APO | PAM02AN3APC |
| 70 x 96 x 55 | 4 | PAM04AN3ANO | PAM04AN3ANC | PAM04AN3APO | PAM04AN3APC |
| 93 x 96 x 55 | 6 | PAM06AN3ANO | PAM06AN3ANC | PAM06AN3APO | PAM06AN3APC |
| 120 x 96 x 55 | 8 | PAM08AN3ANO | PAM08AN3ANC | PAM08AN3APO | PAM08AN3APC |
| 141 x 96 x 55 | 10 | PAM10AN3ANO | PAM10AN3ANC | PAM10AN3APO | PAM10AN3APC |

Note: Female connectors to be ordered separately

Specifications Amplifier

| | | | |
|---|--|--|--|
| Rated operational voltage (U_B) DC | 18 to 33 VDC | Voltage drop (U_d) | ≤ 2 VDC |
| Rated operational power DC supply | 13 W max. | Protection, outputs | Reverse polarity & short-circuit, overload |
| Power ON delay (t_v) | Typ. 1 s | Operating frequency (f) Light/dark ratio 1:1 | 66 Hz (2 channels) 33 Hz (4 channels) 22 Hz (6 channels) 16 Hz (8 channels) 13 Hz (10 channels) |
| Output function | Transistor NPN, make or break function Transistor PNP, make or break function | Response time OFF-ON (t_{ON}) | 7.5 ms (2 channels) 15.0 ms (4 channels) 22.5 ms (6 channels) 30.0 ms (8 channels) 45.0 ms (10 channels) |
| Output current | Continuous (I_e) 20 mA per output | | |
| Min. load current (I_m) | 0.5 mA | | |
| OFF-state current (I_r) | Max. 100 μ A | | |
| Alarm output Continuous (I_e) | 20 mA | | |

Specifications Amplifier (cont.)

| | | | |
|--|--|---|--|
| ON-OFF (t_{OFF}) | 7.5 ms (2 channels) 15.0 ms (4 channels) 22.5 ms (6 channels) 30.0 ms (8 channels) 45.0 ms (10 channels) | Gain overrule input (NPN or PNP) | ≤ 6 V not active ≥ 14 V max. gain |
| Sensitivity (% af Sn) | 2 ranges, • DIP switch selectable -low sensitivity (25%) -high sensitivity (100%) • Fine adjustment with potentiometer Note: • Maximum range indicated on photoelectric switch data sheet in high sensitivity range only. • Operation within low sensitivity range, increases ambient light and crosstalk immunity. | Indication Sensor module Output ON Signal quality Basic module Power supply ON Alarm ON Alignment | LED, yellow LED, red LED, green LED, red Bargraph, Buzzer |
| Auto adjustment input (NPN or PNP) | ≤ 6 V not active ≥ 14 V active | Environment Overvoltage category Degree of protection Pollution degree | III (IEC 60664) IP 20 (IEC 60529, 60947-1) 3 (IEC 60664/60664A, 60947-1) |
| | | Temperature Operating Storage | -20° to +50°C (-4° to +122°F) -50° to +85°C (-58° to 185°F) |
| | | Weight | 100 g (2 channels) 228 g (10 channels) |
| | | CE-marking | Yes |

Type Selection Expansion Kit

| Housing W x H x D | Number of channels | Ordering no. NPN output | Ordering no. PNP output |
|----------------------|-----------------------|----------------------------|----------------------------|
| 27 x 96 x 55 mm | 2 | PAM02CN3ANC | PAM02CN3APC |
| | 2 | PAM02CN3ANO | PAM02CN3APO |
| 48 x 96 x 55 mm | 4 | PAM04CN3ANC | PAM04CN3APC |
| | 4 | PAM04CN3ANO | PAM04CN3APO |

Specifications Expansion Kit

| | | | |
|---|--|--|--|
| Rated operational voltage | Supplied by PAM0XAN3AXX | Indication Output ON Signal quality | LED, yellow LED, red |
| Output function | Transistor NPN, make or break function Transistor PNP, make or break function | Environment Overvoltage category Degree of protection Pollution degree | III (IEC 60664) IP 20 (IEC 60529, 60947-1) 3 (IEC 60664/60664A, 60947-1) |
| Output current Continuous (I_e) | 20 mA per output | Temperature Operating Storage | -20° to +50°C (-4° to +122°F) -50° to +85°C (-58° to 185°F) |
| Min. load current (I_m) | 0.5 mA | Weight | 85 g (4 channels) |
| OFF-state current (I_r) | Max. 100 μ A | CE-marking | Yes |
| Alarm output Continuous (I_e) | 20 mA | | |

Type Selection Relay Module

| DIN-rail type W x H x D | Ordering no. Supply: 18 - 33 VDC |
|----------------------------|-------------------------------------|
| 71 x 46 x 96 mm | PAM 06 156 |

Ordering Key

| | PAM 06 156 |
|------------------------------|------------|
| Relay module | _____ |
| Photoelectric relay module | _____ |
| Number of channels | _____ |
| Number of relays per channel | _____ |
| Relay type | _____ |

Specifications Relay Module

| | | | |
|----------------------------------|---------------------------------|--------------------|--|
| Rated operational voltage | Supplied by PAM0XAN3AXX | Environment | III (IEC 60664) IP 20 (IEC 60529, 60947-1) 3 (IEC 60664/60664A, 60947-1) |
| Resistive load | 8 A/250 VAC 8 A/24 VDC | Temperature | Operating -20° to +50°C (-4° to +122°F) Storage -50° to +85°C (-58° to 185°F) |
| Inductive load | 2 A/230 VAC 3 A/30 VDC | Weight | 170 g |
| Mechanical life | 20 x 10 ⁶ operations | CE-marking | Yes |
| Relay type | SPDT | | |

Mode of Operation

Power up

When power is connected to the system, the Basic Module (BM) will search and identify all the other modules in the system. All LEDs on the sensor modules turn ON for approximately 1.5 seconds. The system is operational after 1.5 seconds.

Indication during operation

A yellow output LED "Y" and a red level LED "R" are present for each sensor channel. A green power LED "G" and a red alarm LED are present on the Basic Module.

System test (for activating see "Test button")

The system is tested as well as the sensors and sensor connection cables. Test mode is indicated by all sensor module LEDs being on for approximately one second. After one second each LED indicates diagnostics.

| Basic module | | Sensor Module | | Function |
|--------------|-----|---------------|-----|--|
| Green | Red | Yellow | Red | |
| ON | - | - | - | Power |
| - | - | ON | - | Sensor output activated, signal sufficient |
| - | - | ON | ON | Sensor output activated, signal insufficient |
| - | - | - | ON | Sensor output not activated, signal sufficient |
| - | - | - | - | No signal |
| - | ON | - | ON | When any of the red LEDs on the sensor module is activated constantly for more than 2.5 seconds, the alarm LED on the Basic Module turns on. LED and buzzer flash with 2 Hz. |

| Sensor module | Function | |
|-------------------------|---------------|------------------------------|
| Yellow | Red | |
| Constantly on | - | All tests OK |
| Flashing | - | Emitter fault |
| - | Flashing | Receiver fault |
| Constantly on | Constantly on | Sensors not correctly paired |
| Flashing alternately | | Signal insufficient |
| Flashing simultaneously | | Emitter and receiver fault |

Basic Module

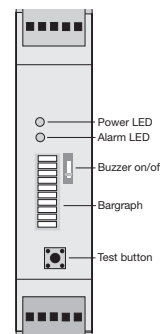

Sensor Module

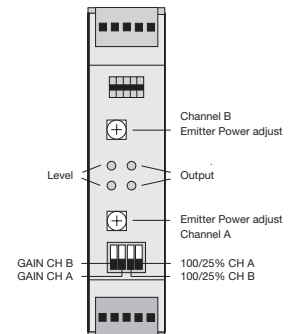

Test button (identical function can be reached by test input)

The Basic Module features a push button to activate system test and alignment help.

System test: Press and release push button once
Alignment: Press and release once more for alignment on channel one. (Step through each channel by pressing the push button several times, the yellow LED indicates the channel being aligned).

Exit: Press and hold for more than 3 seconds and all sensor module LEDs turn ON for approximately 1.5 seconds.

NB! Output is off during test or alignment.

Alignment (for activating see "Test button")

The signal strength is indicated by:

Bargraph - indicates the signal strength by lighting up the LEDs. One LED is weak signal, 10 LEDs is strong signal.

Buzzer - if activated the buzzer changes repetition frequency according to the signal strength, continuous frequency is strong signal.

Alignment output - the alignment output source is a 0 - 10 VDC voltage reflecting the signal strength where 10 VDC is strong signal.

Mode of Operation (cont.)

Outputs (See indication during operation, yellow LED sensor module)

Transistor output
The NPN or PNP output is a standard normally open (make switching) output.

Alarm output (See indication during operation, red LED B. module)

The NPN or PNP alarm output is a normally open (make switching) output.

DIP switches (identical function for Channel A or B)

| Gain | 100% / 25% | Description |
|------|------------|---|
| ON | - | The setting of the channel can be set to 100% by the gain overrule input. |
| OFF | - | The Gain overrule is disabled |
| - | ON | Maximum emitter power is 100% |
| - | OFF | Maximum emitter power is 25% |

Gain settings

Manual: by turning the potentiometer away from minimum position, the emitter power is regulated by the potentiometer.

Automatic: by setting the potentiometer to minimum position, the emitter power is regulated automatically when the "Auto Adjust Input" is activated.

Signal inputs at the Basic Module

Test input (see test button)

The test input function as a remote test button. An active signal will activate the input.

Gain overrule input (see DIP switches)

An active signal will set all channels, with gain function enabled, to 100% power.

Auto adjust input (see gain settings)

An active signal of at least 50 ms will activate the automatic Gain adjustment function on all channels with potentiometer set to minimum position. The automatic gain adjust sequence lasts approximately three seconds.

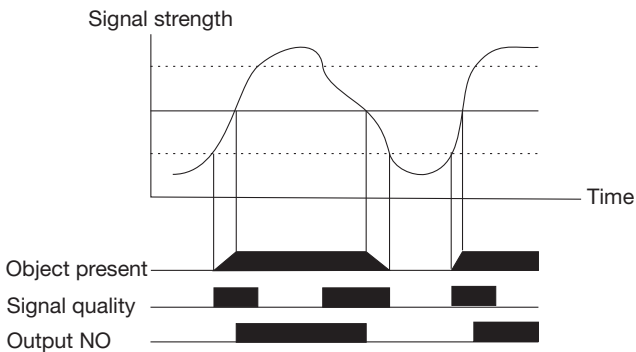

Expansion Kit

It is possible to extend the number of channels up to 10 channels (5 sensor modules). When having a 6 channel amplifier and an expansion kit, the procedure is as described below.

- 1) Remove the label in the right upper corner of the cover.
- 2) Place the expansion kit close to the right side of the amplifier.
- 3) Connect the cable which is delivered together with the expansion kit between the amplifier and the expansion kit.
- 4) Check the positions of the "BUS" jumpers; must be "OUT" on the amplifier and "IN" on the expansion kit (factory default setting).

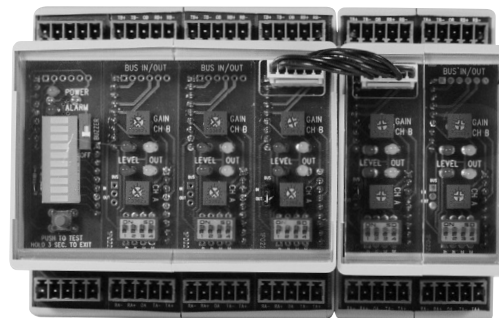

Relay module

It is possible to add a 6-channel relay module. When having a standard amplifier and a relay module, the procedure is as described below.

- 1) Remove the label in the right upper corner of the cover.
- 2) Place the relay module close to the right side of the amplifier.
- 3) Connect the cable which is delivered together with the relay module between the amplifier and the expansion kit.

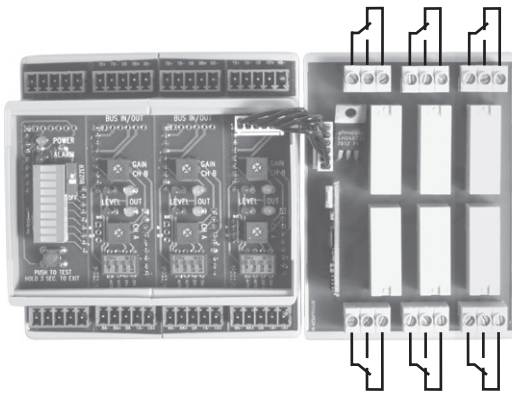

Wiring Diagram

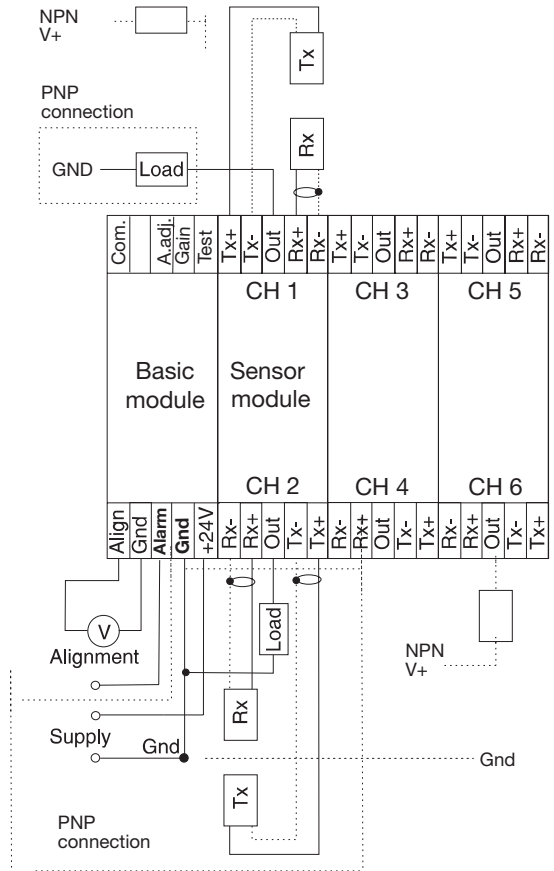

Delivery Contents

| | |
|--|---|
| Amplifier Packaging | 2 to 6 channels Cardboard box |
| Amplifier Expansion Kit Packaging | 8 to 10 channels 6 channel 2 to 4 channel Cardboard box |
| Expansion Kit Sensor module Connection cable Packaging | 2 or 4 channels Cardboard box |
| Relay module Connection cable Packaging | 6 channels Cardboard box |

Accessories

Female connectors:
 Dinkel type EC381V-05P
 Phoenix type MC1,5/5-ST-3,81