



# **WM50**

Multichannel power analyzer  
for single, two and three-phase systems

**INSTRUCTION MANUAL**

# Contents

<b>WM50 and TCD12</b>	<b>5</b>	<b>Measurement management</b>	<b>22</b>
<b>Introduction</b>	<b>5</b>	Measurement error	22
Description	5	Average value calculation (dmd)	22
Architecture	5	Synchronization types	22
Components	6	Total demand distortion calculation (TDD)	22
<b>Component descriptions</b>	<b>6</b>	Voltage asymmetry calculation	23
Main unit - front	6	Filter	23
Main unit - rear	7	<b>Alarms</b>	<b>24</b>
Main unit LED status	7	Introduction	24
Accessory modules	8	Alarm settings for main line variables	24
TCD12	9	Alarm settings for channel or load variables	24
TCD12 LED status	9	Alarm types	24
TCD12WS	10	Start-up condition management	25
UCS (Universal Configuration Software)	10	Latch function	25
UCS function overview	10	Output activation logic	25
		Setting alarms	26
<b>WM50 use</b>	<b>11</b>	<b>Accessory modules</b>	<b>26</b>
<b>Interface</b>	<b>11</b>	Enabling accessory modules	26
Introduction	11	Digital inputs	26
Measurement menu display	11	Notes on digital inputs	26
Settings menu display	11	Digital outputs	27
Reset menu display	12	<b>Tariff management</b>	<b>27</b>
Information menu display	12	Tariff management mode	27
Information and warnings	12	Managing tariffs via Modbus command	27
		Managing tariffs via internal calendar and clock	27
<b>Working with WM50</b>	<b>13</b>	Managing tariffs via digital input	27
Navigating the menus	13	Disabling tariff management	28
Navigation features	13	<b>Database</b>	<b>28</b>
Working with the measurement menu	13	Introduction	28
Working with the settings menu	14	Database content	28
Common operations	14	<b>Date and time</b>	<b>28</b>
Setting a parameter	15	Settings	28
Setting numeric parameters	16	Daylight savings time	28
Saving settings	16	<b>LCD display</b>	<b>29</b>
		Back lighting	29
<b>Menu description</b>	<b>17</b>	LCD bar graph	29
Measurement menu - meters	17	Home page	29
Measurement menu - measurement pages	17	<b>TCD12</b>	<b>29</b>
Settings menu	19	TCD12 identification	29
Information Menu	20		
		<b>Configure the system</b>	<b>30</b>
<b>Essential information</b>	<b>21</b>	<b>Configure WM50</b>	<b>30</b>
<b>Managed measurements</b>	<b>21</b>	Configuration mode	30
Introduction	21	Configuration requirements via UCS	30
Main line measurements	21		
Channel and load measurement (TCD12)	21		

Configuring WM50 via touch keypad	30	Main line measurement precision (main unit)	41
Configuring WM50 via PC or smartphone	30	Channel and load measurement precision (TCD12)	41
<b>Settings from WM50</b>	<b>31</b>	Optical port	41
General settings	31	Memory	41
Accessory modules settings	34	<b>Digital input/output module specifications</b>	<b>41</b>
Running a pulse transmission test	34	M F I6 06 module features	41
Checking accessory module enabling	34	M F I6 R4 module features	42
<b>Configure TCD12s</b>	<b>34</b>	<b>Analog input module features</b>	<b>42</b>
Configure TCD12 layout connected to WM50	34	M A TPN module input features	42
Moving a TCD12	35	<b>Communication module features</b>	<b>42</b>
Replacing a TCD12	35	M C 485232 module	42
<b>Other operations</b>	<b>36</b>	M C ETH module	43
<b>Manage alarms</b>	<b>36</b>	<b>TCD12 current sensor features</b>	<b>43</b>
Reset an alarm via digital input	36	General features	43
Reset an alarm via UCS	36	Environmental specifications	43
Recognize active alarms	36	Electrical specifications	43
<b>Reset meters and values</b>	<b>36</b>	<b>Conformity</b>	<b>43</b>
Reset energy meters and totalizers	36	<b>Part numbers key</b>	<b>43</b>
Reset minimum, maximum, dmd and max dmd values	36	Main unit part number (rear of unit)	43
<b>Communicating with other devices</b>	<b>37</b>	Compatible accessory modules part numbers (rear of module)	43
Communicated via M C ETH module	37	TCD12 part number	44
Communicated via M C 485 232 module	37	TCD12WS cable part number	44
Communicate via OptoProg	37		
<b>Maintenance and disposal</b>	<b>38</b>		
<b>Troubleshooting</b>	<b>38</b>		
Measurement problems	38		
Alarms	38		
Communication problems	38		
Problems during settings	38		
LED	39		
<b>Cleaning</b>	<b>39</b>		
<b>Responsibility for disposal</b>	<b>39</b>		
<b>Features</b>	<b>40</b>		
<b>WM50 common specifications</b>	<b>40</b>		
General features	40		
Environmental specifications	40		
Input and output insulation	40		
<b>Main unit specifications</b>	<b>40</b>		
Electrical specifications	40		
Power supply	40		

## Information property

Copyright © 2017, CARLO GAVAZZI Controls SpA  
All rights reserved in all countries.

CARLO GAVAZZI Controls SpA reserves the right to apply modifications or make improvements to the relative documentation without the obligation of advance notice.

## Safety messages

The following section describes the warnings related to user and device safety included in this document:



**NOTICE:** indicates obligations that if not observed may lead to damage to the device.



**CAUTION!** Indicates a risky situation which, if not avoided, may cause data loss.



**IMPORTANT:** provides essential information on completing the task that should not be neglected.

## General warnings



This manual is an integral part of the product and accompanies it for its entire working life. It should be consulted for all situations tied to configuration, use and maintenance. For this reason, it should always be accessible to operators.



**NOTICE:** no one is authorized to open the analyzer or remove the MABC module. This operation is reserved exclusively for CARLO GAVAZZI technical service personnel.  
*Protection may be impaired if the instrument is used in a manner not specified by the manufacturer.*

## Service and warranty

In the event of malfunction, fault, requests for information or to purchase accessory modules, contact the CARLO GAVAZZI branch or distributor in your country.

Installation and use of analyzers other than those indicated in the provided instructions and removal of the MABC module void the warranty.

## Download

<b>This manual</b>	<a href="http://www.productselection.net/MANUALS/UK/WM50_im_use.pdf">www.productselection.net/MANUALS/UK/WM50_im_use.pdf</a>
<b>Installation instruction - WM50</b>	<a href="http://www.productselection.net/MANUALS/UK/WM50_im_inst.pdf">www.productselection.net/MANUALS/UK/WM50_im_inst.pdf</a>
<b>Installation instruction - TCD12</b>	<a href="http://www.productselection.net/MANUALS/UK/TCD12_im.pdf">www.productselection.net/MANUALS/UK/TCD12_im.pdf</a>
<b>Accessory module user manual</b>	<a href="http://www.productselection.net/MANUALS/UK/WM40MODULES_im.pdf">www.productselection.net/MANUALS/UK/WM40MODULES_im.pdf</a>
<b>UCS desktop</b>	<a href="http://www.productselection.net/Download/UK/ucs.zip">www.productselection.net/Download/UK/ucs.zip</a>
<b>UCS Mobile</b>	Google Play Store
<b>Modbus communication protocol</b>	<a href="http://www.productselection.net/Download">www.productselection.net/Download</a>

# WM50 and TCD12

## Introduction

### Description

WM50 is a multichannel power analyzer for single, two and three-phase systems. Using TCD12 split core current sensors, it can monitor up to 96 single-phase loads or any combination of single and three-phase loads or two and single-phase loads for a maximum of 96 channels. The system can be set up, measurements viewed and up to 16 alarms managed from WM50 and UCS. Main unit functions can be expanded with a maximum of two of the following available modules: digital input/output module, analog input module and communication module.

### Architecture

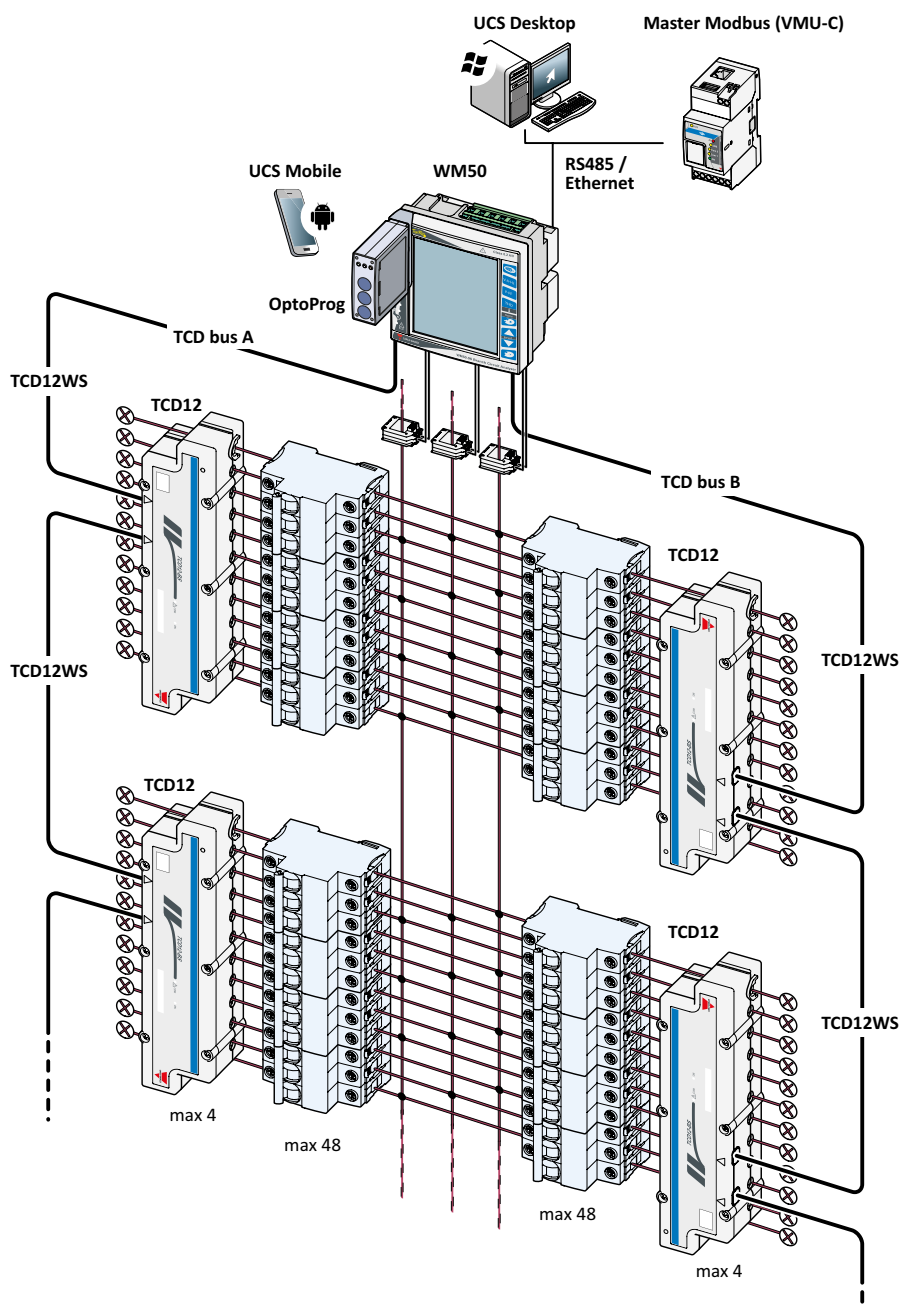

## Components

Component	Description																
<b>WM50</b>	Main unit, measures and displays the main line electrical variables via current sensors. With LCD display and touch keypad, it lets you set measurements parameters, configure accessory modules and manage up to 16 alarms. It communicates with TCD12 current sensors via pre-installed MABC module to monitor up to 96 channels.																
<b>Accessory modules (optional)</b>	Connected to the main unit via local bus, the following expand WM50 functions:																
	<table border="1"> <thead> <tr> <th>Type</th> <th>Module description</th> <th>Part number</th> </tr> </thead> <tbody> <tr> <td rowspan="2">Digital inputs/outputs</td> <td>Six digital inputs and six static outputs</td> <td>M F I6 O6</td> </tr> <tr> <td>Six digital inputs and four relay outputs</td> <td>M F I6 R4</td> </tr> <tr> <td>Analog inputs</td> <td>Three analog inputs (neutral current, temperature probe, 20 mA input)</td> <td>M A TPN</td> </tr> <tr> <td rowspan="2">Communication</td> <td>Modbus RTU communication on RS485/RS232</td> <td>M C 485 232</td> </tr> <tr> <td>Modbus TCP/IP communication on Ethernet</td> <td>M C ETH</td> </tr> </tbody> </table>	Type	Module description	Part number	Digital inputs/outputs	Six digital inputs and six static outputs	M F I6 O6	Six digital inputs and four relay outputs	M F I6 R4	Analog inputs	Three analog inputs (neutral current, temperature probe, 20 mA input)	M A TPN	Communication	Modbus RTU communication on RS485/RS232	M C 485 232	Modbus TCP/IP communication on Ethernet	M C ETH
	Type	Module description	Part number														
	Digital inputs/outputs	Six digital inputs and six static outputs	M F I6 O6														
		Six digital inputs and four relay outputs	M F I6 R4														
Analog inputs	Three analog inputs (neutral current, temperature probe, 20 mA input)	M A TPN															
Communication	Modbus RTU communication on RS485/RS232	M C 485 232															
	Modbus TCP/IP communication on Ethernet	M C ETH															
<b>TCD12</b>	12-channel current sensor. Measures main electrical variables on the single channels and loads and transmits them to WM50. A maximum of eight TCD12s can be connected in series on two TCD buses to each WM50 via TCD12WS cables.																
<b>UCS</b>	Configuration and diagnostics software. Available for both PC and Android mobile devices.																
<b>OptoProg (optional)</b>	Optical communication interface to configure the analyzer and TCD12s or to read data in real-time from PC or mobile devices via UCS.																
<b>Master Modbus (optional)</b>	Supervision system for WM50 data analysis and monitoring.																

## Component descriptions

### Main unit - front

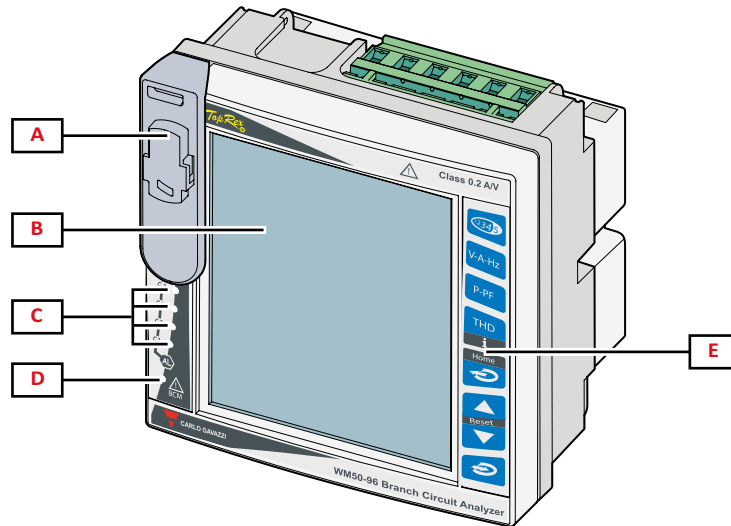

Part	Description
<b>A</b>	Optical port and plastic support for OptoProg connection ⚠ make sure that the plastic support is removed only during programming by skilled people, and is kept in place during normal working, in order to avoid risk of electric shock.
<b>B</b>	Backlit LCD display. The backlight time, color and behavior in the event of alarm can be set.
<b>C</b>	Alarm LEDs, see "Main unit LED status" on page 7
<b>D</b>	MABC module status LED ⚠ refer to the instructions for use, see "Main unit LED status" on page 7
<b>E</b>	Touch keypad

## Main unit - rear

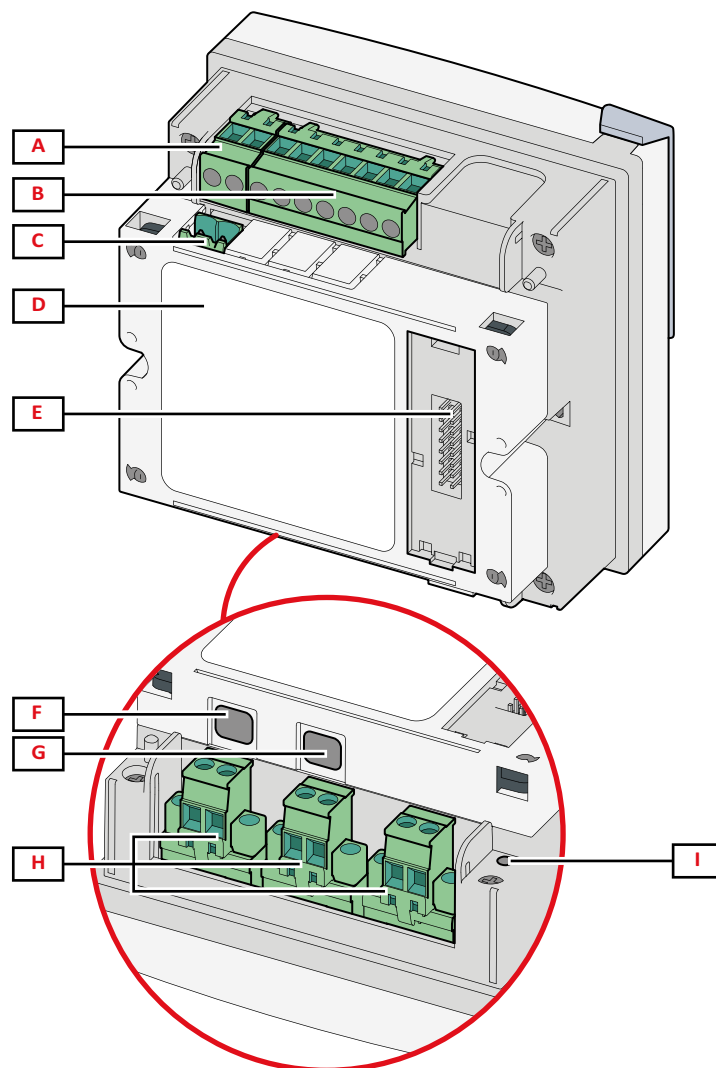

Part	Description
A	Detachable power supply terminal block
B	Detachable voltage input terminal block
C	Detachable functional grounding terminal block
D	MABC module (irremovable) for communications with TCD12 current sensors
E	Local bus port for accessory modules
F	B port for TCD12 bus
G	A port for TCD12 bus
H	Detachable current input terminal block
I	Power supply status LED, see "Main unit LED status" below

## Main unit LED status

G1	Alarm 1, 2, 3, 4 status	Off: no active alarm.
G2	Alarm 5, 6, 7, 8 status	On: at least one active alarm. <b>Note:</b> to identify which alarm is activated, use UCS.
G3	Alarm 9, 10, 11, 12 status	All blinking: TCD12 configuration inconsistent with set electrical system.
G4	Alarm 13, 14, 15, 16 status	<b>Note:</b> for details on the type of inconsistency, see the <b>Warning</b> page in "Settings menu" on page 19.

<b>BCM</b>	TCD12 monitoring status	Off: TCD12 monitoring on. On: TCD12 monitoring not working. Blinking: communication error with at least one TCD12 or at least one TCD12 not configured or inconsistent with the set configuration.
<b>Back</b>	Power supply status	On: WM50 power on. Off: WM50 power off.

**Note:** for problem solutions, see “Troubleshooting” on page 38.

## Accessory modules

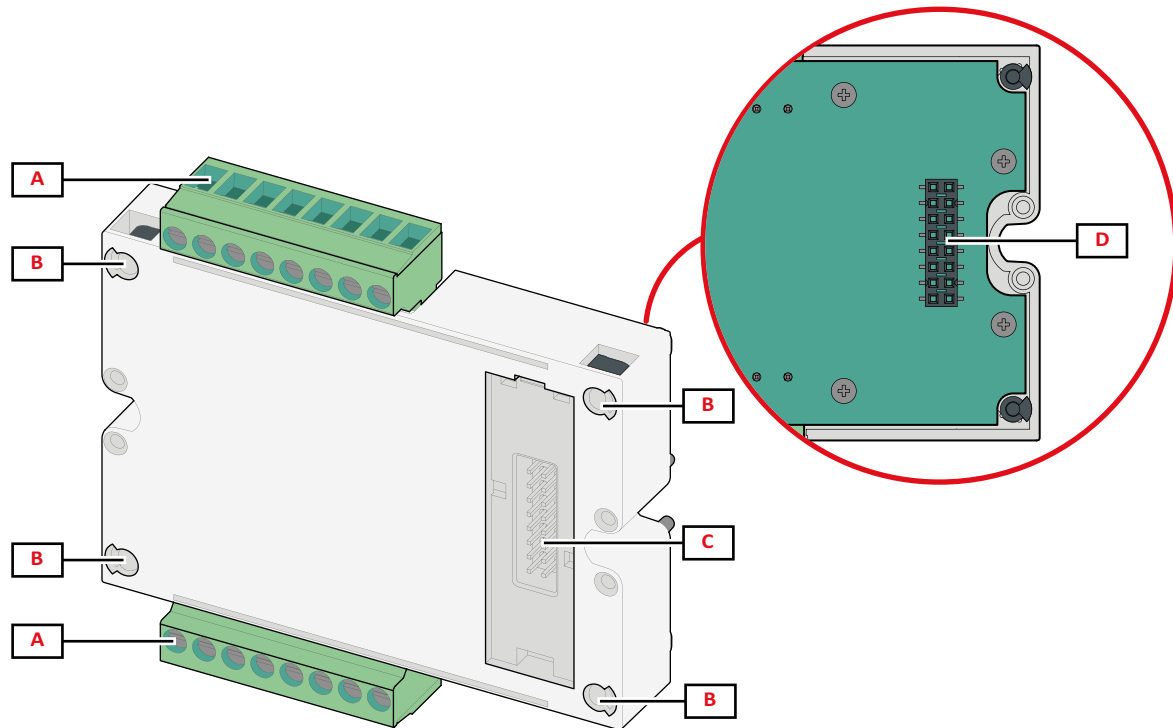

Part	Description
<b>A</b>	Detachable terminal block for inputs/outputs or area specific to communication ports
<b>B</b>	Fastening pins to main unit or other accessory module
<b>C</b>	Internal local bus port for communications with main unit or other accessory module
<b>D</b>	External local bus port for communication with communication module. Not included in communication modules.



TCD12

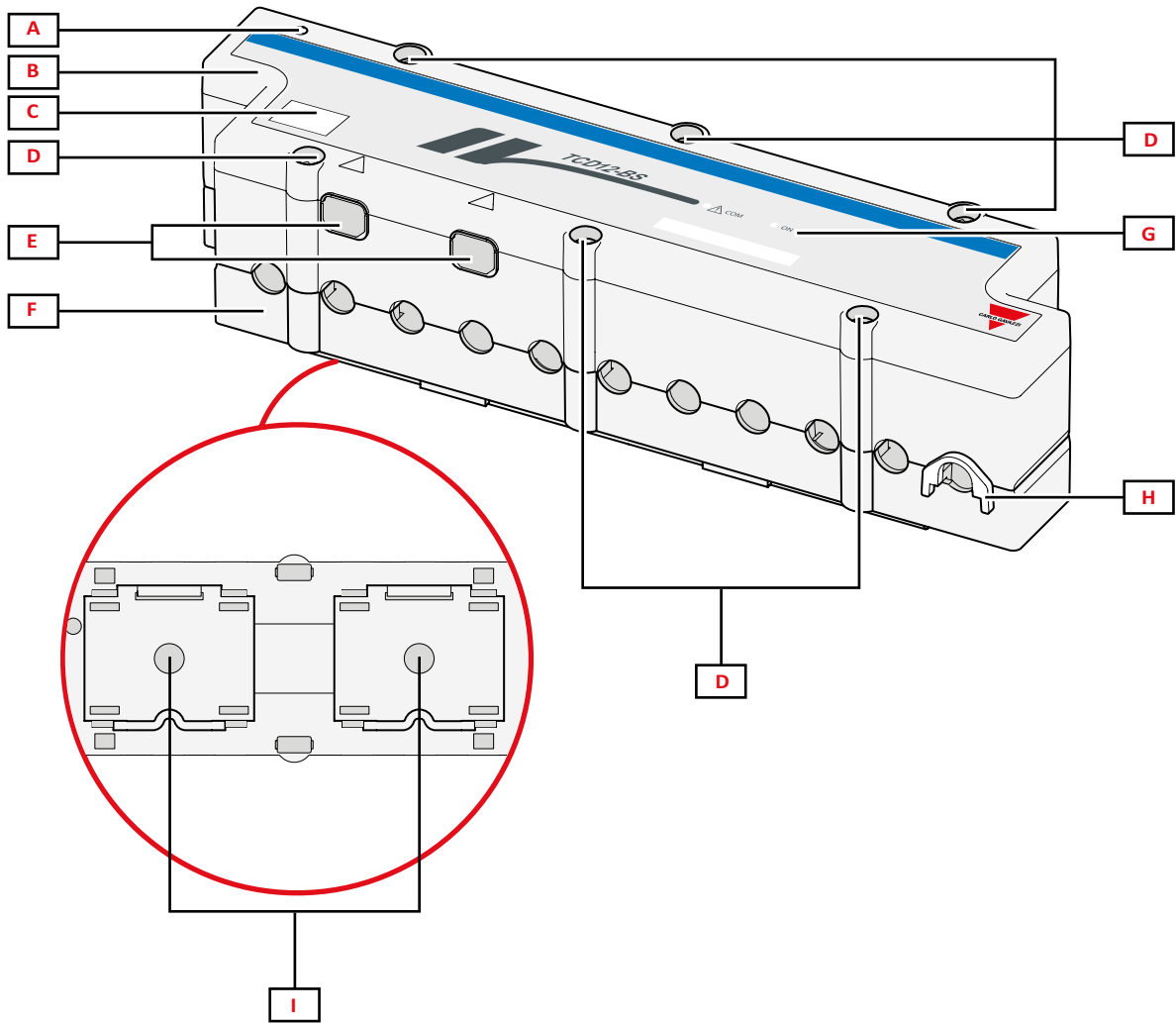

Part	Description
A	Indicator of the channel considered by default as the first one of the managed channel group. The order can be reversed during configuration.
B	Top
C	Device identification marking area
D	Top and bottom fastening screws
E	Connection port with WM50 or other TCD12 via TCD12WS cable
F	Bottom
G	Status LED, see "TCD12 LED status" below
H	Removable clips for cable fastening
I	Removable adapters for DIN rail mounting

TCD12 LED status

COM	Communication status with WM50	Off: communications correctly working On: communication error Blinking: TCD12 not configured or not consistent with the set configuration
ON	Power supply status	Off: no power supply On: powered Blinking: TCD12 identification function on

Note: for problem solutions, see "Troubleshooting" on page 38.

## TCD12WS

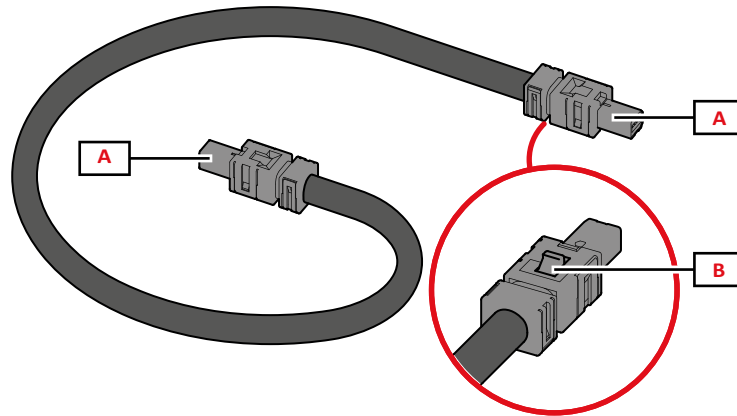

Part	Description
A	Connection cables with WM50 or TCD12
B	Tab for connector removal

## UCS (Universal Configuration Software)

UCS is available in desktop and mobile versions.

It can connect to WM50 via accessory communication modules (Modbus TCP/IP or Modbus RTU protocol) or via OptoProg (via USB or Bluetooth).

The following is possible with UCS:

- configure WM50, including accessory modules and current sensors
- view system status for diagnostics and configuration checks

## UCS function overview

Function	UCS desktop	UCS Mobile
Configure the system with WM50 connected (online configuration)	x	x
Configure the system with WM50 disconnected (offline configuration)	x	x
View main measurement *	x	x
View input and output status *	x	x
View main unit, channel and load alarm status *	x	x
Record selected variable measurements *	x	-
View help to install WM50 and connect with OptoProg	-	x

**Note** \*: functions only available with WM50 connected.

# WM50 use

## Interface

### Introduction

WM50 is organized in four menus:

- measurement menu: pages used to display meters and other electrical variables
- settings menu: pages used to set parameters of the main unit and accessory modules
- reset menu: pages to reset minimum, maximum, average (dmd) and maximum among averages values (max dmd) for variables in measured pages
- information menu: pages that display general and set parameter information

### Measurement menu display

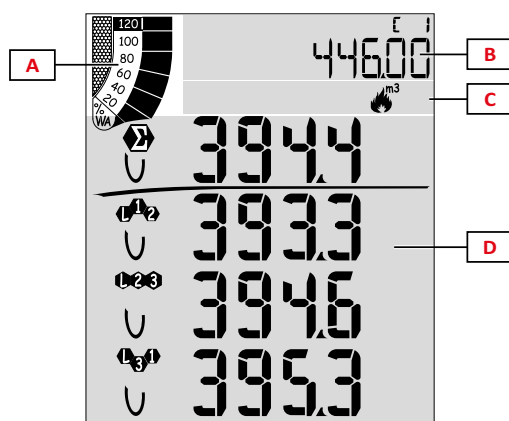

Part	Description
A	Graph with percentage of active or apparent real-time power, see "LCD bar graph" on page 29
B	Meters, see "Measurement menu - meters" on page 17. These are displayed independently from the contents displayed in area D.
C	Warning and information area, see "Information and warnings" on page 12
D	Measurement page area with electric variables and relevant units of measure (for four rows), see "Measurement menu - measurement pages" on page 17.

### Settings menu display

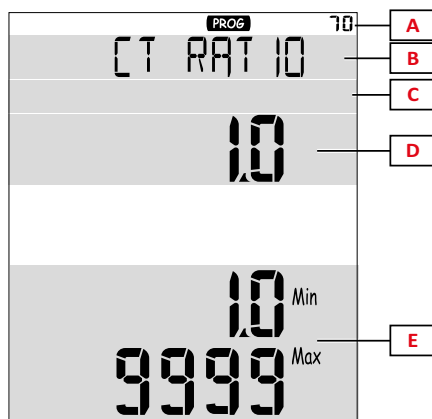

Part	Description
A	Page identification number
B	Page title, see "Settings menu" on page 19
C	Warning and information area, see "Information and warnings" on page 12
D	Current value/option
E	Possible value/option range

## Reset menu display

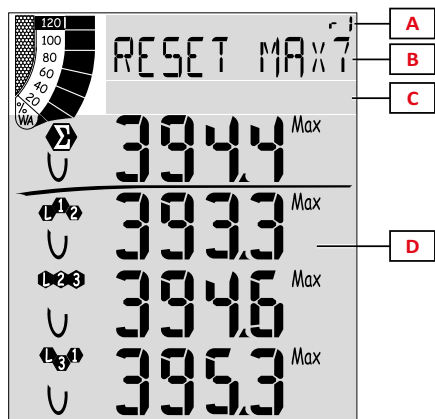

Part	Description
A	Page identification number
B	Page title with reset object
C	Warning and information area, see "Information and warnings" below
D	Current values

## Information menu display

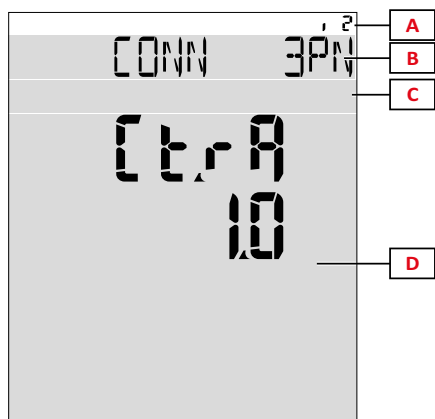

Part	Description
A	Page identification number
B	Page title, see "Settings menu" on page 19
C	Warning and information area, see "Information and warnings" below
D	Current page information

## Information and warnings

Symbol	Description
	Alarm information page
	Settings menu page
	Voltage connection error (inverted sequence)
	Hot water totalizer (m³)
	Cold water totalizer (m³)
	Hot water energy totalizer (kWh)

Symbol	Description
	Gas totalizer (m³)
	Feedback after pressing a button
	Serial or optical communication status (receiving/transmitting)

## Working with WM50

### Navigating the menus

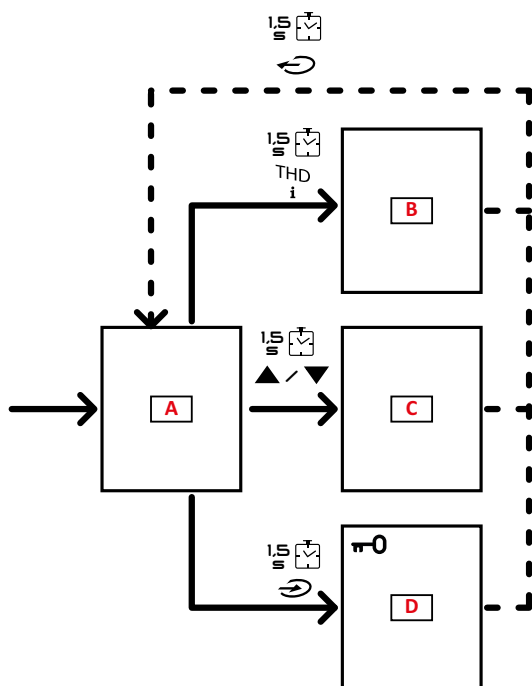

Section	Function
A	Measurement menu
B	Information menu
C	Reset menu for displayed measurement page
D	Settings menu







**CAUTION!** If you exit the settings menu by pressing button  per 1.5 s or automatically after 2 minutes of inactivity, changes will not be saved.

### Navigation features









The measurement menu home page is displayed when the device is turned on. The home page appears after 120 s of inactivity. The information menu, settings menu and relevant reset menu can be opened from any menu page.

**Note:** the settings menu is password protected.

### Working with the measurement menu





Operation	Button
Scroll meters. See "Measurement menu - meters" on page 17.	
Scroll voltage, current, frequency group pages. See "Voltage, current, frequency group" on page 17.	V-A-Hz
Scroll power, power factor group pages. See "Power, power factor group" on page 17.	P-PF
View the temperature and analog input value of the MATPN accessory module. See "M A TPN module page" on page 18.	P-PF  
Scroll THD group pages. See "THD group" on page 18.	THD i
View the measurement page set as the Home page.	
Scroll minimum, maximum, average (dmd) and maximum among averages values (max dmd) for variables in displayed page.	

## Working with the settings menu

Operation	Button
Move among value positions *	
Exit the sub-menu and view relative title page	
Increase a parameter value / View the next value option/ Modify the value in positions dP and Sign*	
Decrease a parameter value / View the previous value option/ Modify the value in positions dP and Sign*	
Enter the sub-menu/Modify parameter of the page on display	
Save changes and exit the menu	 in the <b>End</b> page
Exit the menu without saving changes	 , then  in the <b>Exit menu?</b> page

**Note** \*: for details, see "Setting numeric parameters" on page 16.

## Common operations

Operation	Button
Confirm operation	
View the previous/next page	 / 
Cancel operation	

## Setting a parameter

When setting a parameter, **E** indicates the edited row, the blinking dash the number.  
Example procedure: how to set **Filter co**=25 and save changes.

**Note:** the initial procedure status is the **Filter co** page in the settings menu.

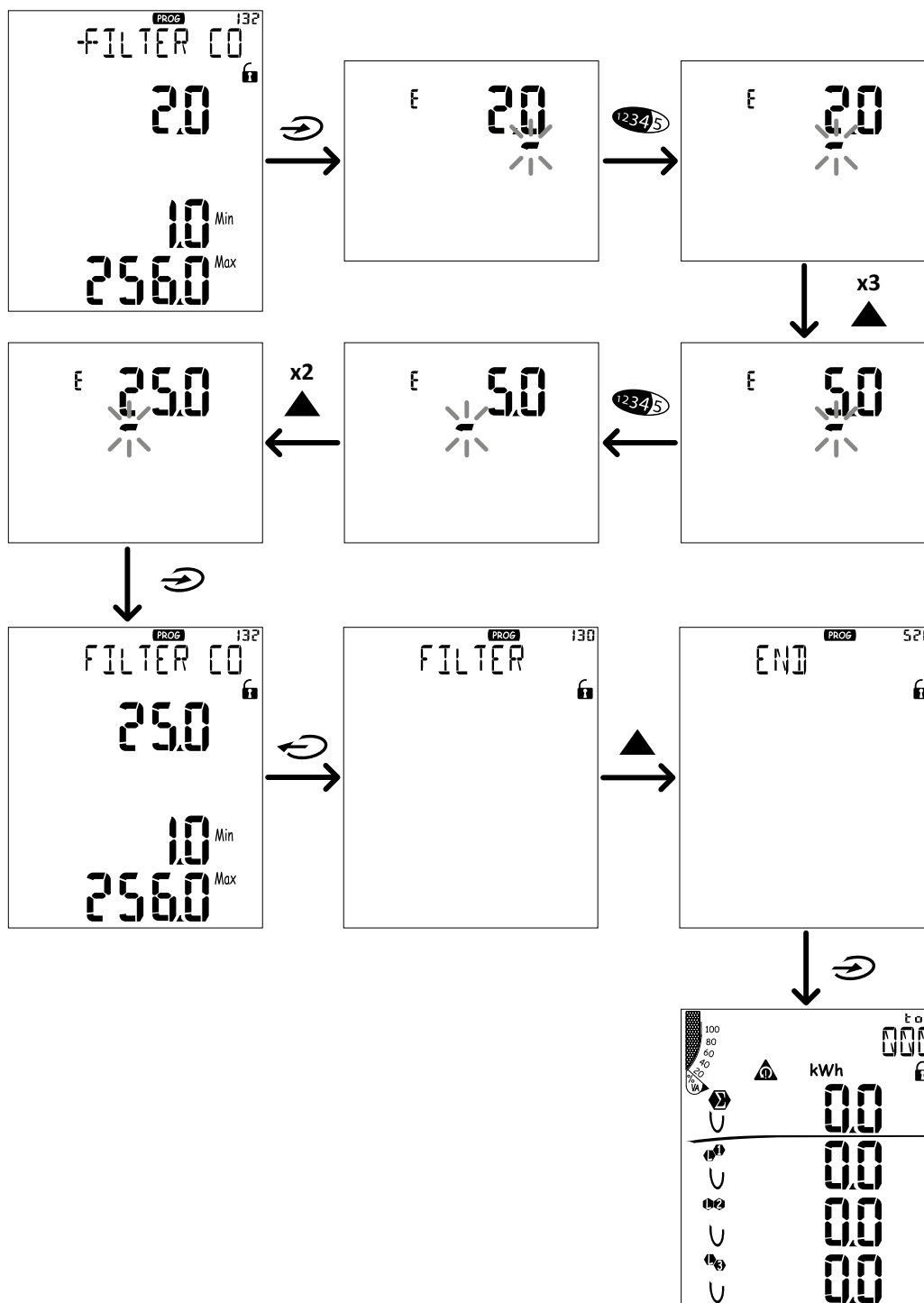

## Setting numeric parameters

### Order of positions

The value of a numerical parameter is made up of six positions: four digits, decimal point (**dP**) and sign (**Sign**). The button **12345** is used to select the positions in the following order:

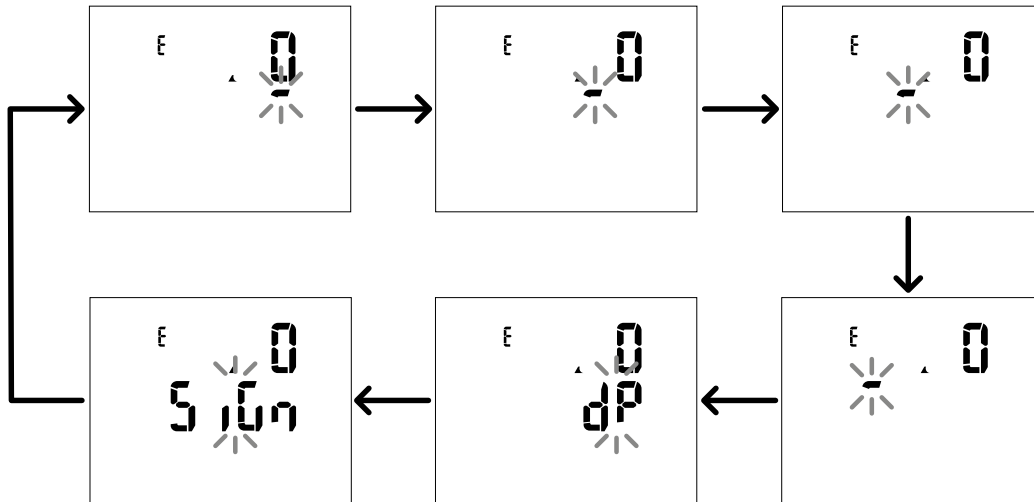

### Decimal point position (dP)

In the **dP** position, buttons ▲ and ▼ can be used to enable decimal point movement and set a multiplier (**k** x 1000, **M** x 1000000) in the following order:



### Sign position (Sign)

The value sign can be set in the position **Sign**. The value is positive by default.

## Saving settings

To save settings, scroll the settings menu pages until the **End** page is displayed and press **↻**.



**CAUTION! Changes are not saved if you exit the settings menu in another way.**



## Menu description

### Measurement menu - meters

A list of the meters displayed is provided below:

**Note:** displayed meters depend on whether M F I6 O6 and M F I6 R4 module inputs are installed and their settings and whether tariff management is enabled.

Symbol	Description
<b>tot (kWh)</b>	Total imported active energy
<b>tot (kvarh)</b>	Total imported reactive energy
<b>tot (- kWh)</b>	Total exported active energy
<b>tot (- kvarh)</b>	Total exported reactive energy
<b>PAr (kWh)</b>	Partial imported active energy
<b>PAr (kvarh)</b>	Partial imported reactive energy
<b>PAr (- kWh)</b>	Partial exported active energy
<b>PAr (- kvarh)</b>	Partial exported reactive energy
<b>t0x (kWh)</b>	Active energy per tariff x
<b>t0x (kvarh)</b>	Reactive energy per tariff x

Symbol	Description
<b>t0x (- kWh)</b>	Active energy per tariff x
<b>t0x (- kvarh)</b>	Reactive energy per tariff x
<b>C1</b>	Pulse totalizer 1, associated with digital input 4
<b>C2</b>	Pulse totalizer 2, associated with digital input 5
<b>C3</b>	Pulse totalizer 3, associated with digital input 6
<b>HrS</b>	Total load operating hours
<b>d t</b>	Date and time

### Measurement menu - measurement pages

The minimum, maximum, average (dmd) and maximum among average values (max dmd) for each displayed variable can be viewed for each measurement, touching keys ▲/▼.

**Note:** the available measurements depend on the type of system set.

#### Voltage, current, frequency group

Displayed measurements	Description
$V_{LN\Sigma}$	System phase-neutral voltage
$V_{L1}$	Phase 1 voltage
$V_{L2}$	Phase 2 voltage
$V_{L3}$	Phase 3 voltage
$V_{LL\Sigma}$	System phase-phase voltage
$V_{L12}$	Phase 1-phase 2 voltage
$V_{L23}$	Phase 2-phase 3 voltage
$V_{L31}$	Phase 3-phase 1 voltage
$A_N$	Neutral current
$A_{L1}$	Phase 1 current
$A_{L2}$	Phase 2 current
$A_{L3}$	Phase 3 current

Displayed measurements	Description
<b>Hz</b>	Frequency
<b>ASY</b>	-
$V_{LL}\%$	Phase-phase voltage asymmetry
$V_{LN}\%$	Phase-neutral voltage asymmetry
$A_{\Sigma}$	System current
$A_{L1}$	Phase 1 current
$A_{L2}$	Phase 2 current
$A_{L3}$	Phase 3 current

#### Power, power factor group

Displayed measurements	Description
$VA_{\Sigma}$	System apparent power
$VA_{L1}$	Phase 1 apparent power
$VA_{L2}$	Phase 2 apparent power
$VA_{L3}$	Phase 3 apparent power
$VAR_{\Sigma}$	System reactive power
$VAR_{L1}$	Phase 1 reactive power
$VAR_{L2}$	Phase 2 reactive power
$VAR_{L3}$	Phase 3 reactive power

Displayed measurements	Description
$W_{\Sigma}$	System active power
$W_{L1}$	Phase 1 active power
$W_{L2}$	Phase 2 active power
$W_{L3}$	Phase 3 active power
$PF_{\Sigma}$	System power factor
$PF_{L1}$	Phase 1 power factor
$PF_{L2}$	Phase 2 power factor
$PF_{L3}$	Phase 3 power factor

WM50 use

THD group

**Note:** single harmonic values can also be viewed from UCS.

Displayed measurements	Description
<b>V<sub>1</sub> THD %</b>	THD of phase 1 voltage
<b>V<sub>2</sub> THD %</b>	THD of phase 2 voltage
<b>V<sub>3</sub> THD %</b>	THD of phase 3 voltage
<b>V<sub>L12</sub> THD %</b>	THD of phase 1-phase2 voltage
<b>V<sub>L23</sub> THD %</b>	THD of phase2-phase3 voltage
<b>V<sub>L31</sub> THD %</b>	THD of phase3-phase1 voltage
<b>A<sub>L1</sub> THD %</b>	THD of phase 1 current
<b>A<sub>L2</sub> THD %</b>	THD of phase 2 current
<b>A<sub>L3</sub> THD %</b>	THD of phase 3 current
<b>EVEN</b>	
<b>V<sub>1</sub> THD %</b>	Even THD of phase 1 voltage
<b>V<sub>2</sub> THD %</b>	Even THD of phase 2 voltage
<b>V<sub>3</sub> THD %</b>	Even THD of phase 3 voltage
<b>EVEN</b>	
<b>V<sub>L12</sub> THD %</b>	Even THD of phase 1-phase2 voltage
<b>V<sub>L23</sub> THD %</b>	Even THD of phase2-phase3 voltage
<b>V<sub>L31</sub> THD %</b>	Even THD of phase3-phase1 voltage
<b>EVEN</b>	
<b>A<sub>L1</sub> THD %</b>	Even THD of phase 1 current
<b>A<sub>L2</sub> THD %</b>	Even THD of phase 2 current
<b>A<sub>L3</sub> THD %</b>	Even THD of phase 3 current

Displayed measurements	Description
<b>odd</b>	
<b>V<sub>1</sub> THD %</b>	Odd THD of phase 1 voltage
<b>V<sub>2</sub> THD %</b>	Odd THD of phase 2 voltage
<b>V<sub>3</sub> THD %</b>	Odd THD of phase 3 voltage
<b>odd</b>	
<b>V<sub>L12</sub> THD %</b>	Odd THD of phase 1-phase2 voltage
<b>V<sub>L23</sub> THD %</b>	Odd THD of phase2-phase3 voltage
<b>V<sub>L31</sub> THD %</b>	Odd THD of phase3-phase1 voltage
<b>odd</b>	
<b>A<sub>L1</sub> THD %</b>	Odd THD of phase 1 current
<b>A<sub>L2</sub> THD %</b>	Odd THD of phase 2 current
<b>A<sub>L3</sub> THD %</b>	Odd THD of phase 3 current
<b>A<sub>L1</sub> TDD %</b>	TDD of phase 1 current
<b>A<sub>L2</sub> TDD %</b>	TDD of phase 2 current
<b>A<sub>L3</sub> TDD %</b>	TDD of phase 3 current

M A TPN module page

Displayed measurements	Description
<b>Matp</b>	Analog input
<b>°C/°F</b>	Temperature



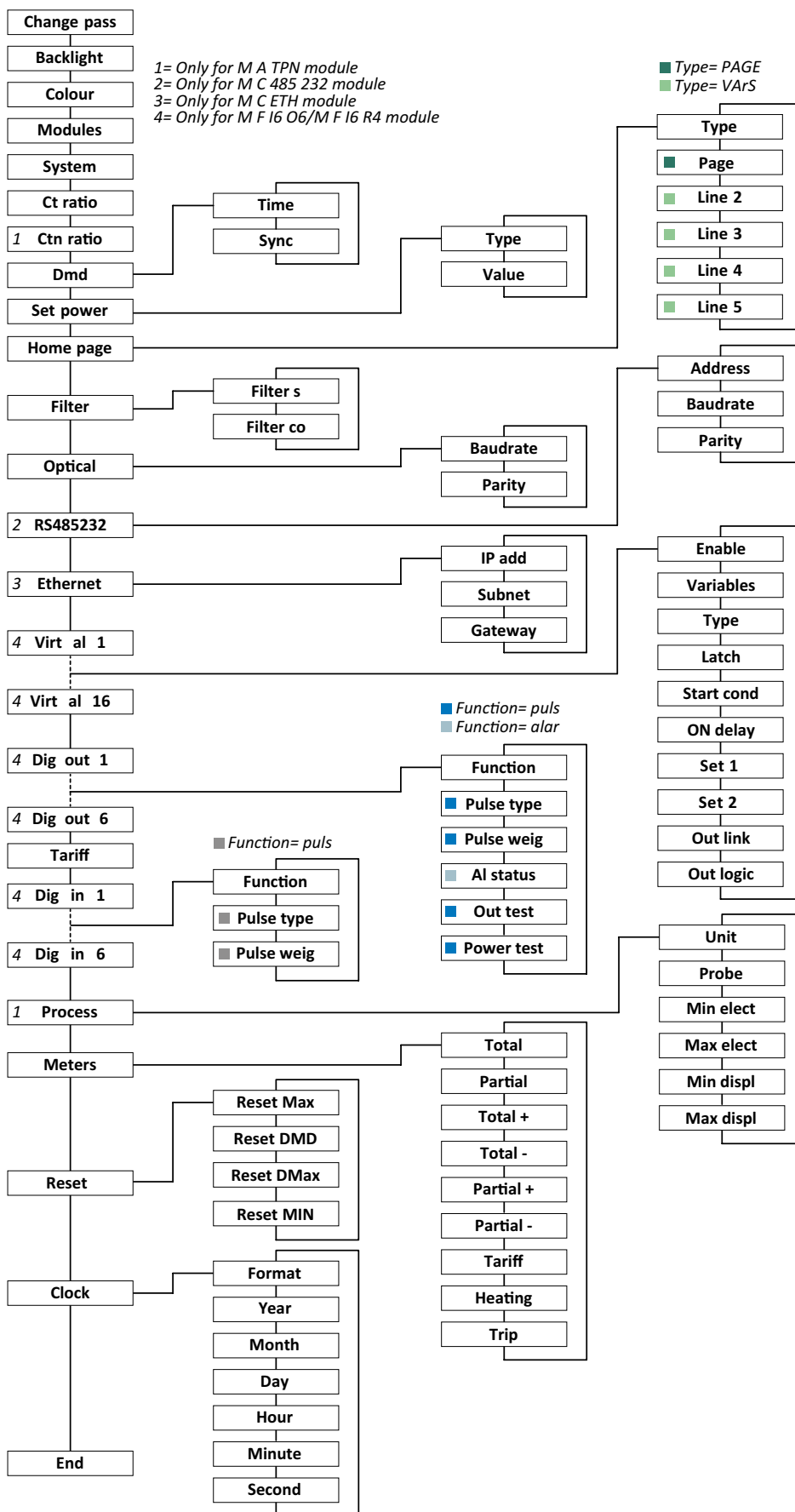









## Settings menu



**Note:** for the description of all settings, possible and default values, see "Settings from WM50" on page 31.

## Information Menu

**Note:** in general, presence of the pages depends on the installed accessory modules. The **Data events** page is only included if the relevant database is enabled.

Page title	Information displayed																		
12345678	<ul style="list-style-type: none"> <li>Serial number (page title)</li> <li>Year of manufacture</li> <li>Firmware revision</li> <li>Average value calculation interval (dmd)</li> </ul>																		
Conn	<ul style="list-style-type: none"> <li>System type (in title)</li> <li>Current transformer ratio (<b>Ct</b>)</li> </ul> <p><b>Note:</b> any neutral current transformer ratio is not displayed.</p>																		
Pulse out x	<ul style="list-style-type: none"> <li>x = output number (in title)</li> <li><b>none</b>: output not set as pulse output</li> <li>If the output is set as pulse output, it displays: <ul style="list-style-type: none"> <li>Associated energy meter</li> <li>Pulse weight</li> </ul> </li> </ul>																		
Remot out (3 pages)	Outputs set as remote control and relevant status																		
Warning	<p>TCD12 warnings:</p> <ul style="list-style-type: none"> <li><b>none</b>: no warnings</li> <li><b>E001</b>: channels associated to a phase not foreseen by the set electrical system</li> <li><b>E002</b>: two-phase or three-phase load set with two channels associated with the same phase</li> <li><b>E003</b>: set load inconsistent with the set electrical system (i.e.: three-phase load, two-phase electrical system)</li> </ul>																		
Al x	<ul style="list-style-type: none"> <li>x = alarm number (in title)</li> <li>Alarm data x (in title):</li> <li><b>None</b>: alarm disabled</li> <li><b>Virt</b>: alarm enabled but not associated with any output</li> <li><b>Out x YY</b>: alarm enabled, associated with digital output x with normal YY output status (<b>ND</b> = normally open or <b>NE</b> = normally closed)</li> <li>Controlled variable</li> <li>Alarm activation threshold (Set 1)</li> <li>Alarm deactivation threshold (Set 2)</li> <li>Alarm type:</li> </ul> <table border="1" style="width: 100%; border-collapse: collapse;"> <thead> <tr> <th style="width: 50%;">Symbol</th> <th style="width: 50%;">Description</th> </tr> </thead> <tbody> <tr> <td style="text-align: center;"></td> <td>Up</td> </tr> <tr> <td style="text-align: center;">▲▲</td> <td></td> </tr> <tr> <td style="text-align: center;"></td> <td>Down</td> </tr> <tr> <td style="text-align: center;">▼▼</td> <td></td> </tr> </tbody> </table> <table border="1" style="width: 50%; margin-left: auto; border-collapse: collapse;"> <thead> <tr> <th style="width: 20%;">Symbol</th> <th style="width: 80%;">Description</th> </tr> </thead> <tbody> <tr> <td style="text-align: center;"></td> <td rowspan="2">Out of window</td> </tr> <tr> <td style="text-align: center;">▼▼</td> </tr> <tr> <td style="text-align: center;"></td> <td rowspan="2">In window</td> </tr> <tr> <td style="text-align: center;">▲▲</td> </tr> </tbody> </table>	Symbol	Description		Up	▲▲			Down	▼▼		Symbol	Description		Out of window	▼▼		In window	▲▲
Symbol	Description																		
	Up																		
▲▲																			
	Down																		
▼▼																			
Symbol	Description																		
	Out of window																		
▼▼																			
	In window																		
▲▲																			
Optical	Baud rate of optical port																		
Com port	Modbus address Baud rate of RS485/RS232 port																		
IP address	IP address																		
Date	Date																		
time	Hour																		
Data events	Number of events recorded in the main unit event database.																		

# Essential information

## Managed measurements

### Introduction

WM50 calculates and displays both main line and single channel and load measurements. All measurements are displayed by UCS or via Modbus communications (Carlo Gavazzi VMU-C monitoring system or other data acquisition system). Main line measurements are also available on screen.

### Main line measurements

**Note:** the following values are available for all measurements: minimum, maximum, average (dmd) and maximum average (max dmd). The available variables depend on the type of system set. Minimum and maximum values are calculated only considering valid values and not out of range values.

<b>Active energy/Reactive energy</b>	Total, partial and by tariff. <ul style="list-style-type: none"> <li>Imported</li> <li>Exported</li> </ul>
<b>Totalizers</b>	Up to three totalizers. <ul style="list-style-type: none"> <li>Gas</li> <li>Cold water</li> <li>Hot water</li> <li>Heat</li> <li>Protection trips</li> </ul>
<b>Current</b>	<ul style="list-style-type: none"> <li>Neutral</li> <li>Phase</li> <li>System</li> </ul>
<b>Voltage</b>	<ul style="list-style-type: none"> <li>Phase-phase</li> <li>Phase-neutral</li> <li>System</li> </ul>
<b>Total harmonic distortion (THD)</b>	Up to 32 <sup>nd</sup> harmonic. Total, even and odd. <ul style="list-style-type: none"> <li>Phase current</li> <li>Phase-phase voltage</li> <li>Phase-neutral voltage</li> </ul> <p><b>Note:</b> even single harmonics from UCS.</p>

<b>Total demand distortion (TDD)</b>	Phase current
<b>Power</b>	Reactive, active, apparent. <ul style="list-style-type: none"> <li>Phase</li> <li>System</li> </ul>
<b>Power factor</b>	<ul style="list-style-type: none"> <li>Phase</li> <li>System</li> </ul>
<b>Frequency</b>	System
<b>Voltage asymmetry</b>	<ul style="list-style-type: none"> <li>Phase-phase</li> <li>Phase-neutral</li> </ul>

**Note:** main line energy meter values may differ from the total of single channel energy meters. This is because they are measured with a different precision class (main line: class 0.5S, channels: class 2).

### Channel and load measurement (TCD12)

<b>Single channel</b>	<ul style="list-style-type: none"> <li>Current</li> <li>Current THD (up to 15th harmonics)</li> <li>Active/reactive/apparent power</li> <li>Power factor</li> <li>Active energy</li> </ul>
<b>Load</b>	<ul style="list-style-type: none"> <li>Voltage</li> <li>Each phase current</li> <li>Each phase current THD (up to 15th harmonics)</li> <li>Active/reactive/apparent power</li> <li>Power factor</li> <li>Active energy</li> </ul>
<b>Variable selected for advanced monitoring</b>	<ul style="list-style-type: none"> <li>Daily minimum and maximum values</li> <li>Real-time minimum, maximum and average values (dmd)</li> </ul>

**Note:** the single channel and load variable can be selected via UCS to manage alarms with differentiated thresholds for each channel/load and view daily minimum and maximum values and real-time minimum, maximum and average values (dmd). Minimum and maximum values are calculated only considering valid values and not out of range values.

**Note:** a Modbus protocol table can be set from UCS to customize and facilitate TCD12 variable reading. See "Modbus communication protocol" on page 4 for further information.

## Measurement management

### Measurement error

If a measurement is not available or out of range, it is displayed as "EEEE" on WM50 display and as "--" on UCS. See "Troubleshooting" on page 38.

### Average value calculation (dmd)

The system calculates the average value of electrical variables in a set integration interval (15 min by default). The average value will not be available if the variable measurement is out of range.

By default, the integration interval is calculated from when the analyzer is turned on. To guarantee calculation alignment, it can be synchronized using the internal clock. In turn, the internal clock can be synchronized with an external reference via digital input (i.e.: from the electric manufacturer's device).

### Synchronization types

Following is information on average value calculation rules based on the type of synchronization:

Synchronization type	Integration interval start	First displayed value	Digital input effect with synchronization function	Example
Disabled	When turned on, at the end of start-up	At the end of the first integration interval	None	<b>On:</b> at 11:28 <b>Set integration time:</b> 15 min <b>First value displayed:</b> at 11:43 for the 11:28 to 11:43 interval
By internal clock	At the first multiple of the integration interval, using the internal clock as a reference, starting from 00:00	At the end of the first integration interval	None	<b>On:</b> at 11:28 <b>Set integration time:</b> 15 min <b>First displayed value:</b> at 11:45 for the interval from 11:30 (first integration interval multiple) to 11:45
Via internal clock synchronized via digital input *	At the first multiple of the integration interval, using the internal clock as a reference, starting from 00:00, or at the first digital input contact	At the end of the first integration interval or at first contact after integration starts	The internal clock moves to the closest set integration time multiple starting from 00:00	<b>On:</b> at 11:28 <b>Set integration time:</b> 15 min  <b>CAUTION! The interval between synchronism contacts must be an integer multiple of the set integration interval.</b> <b>Synchronism contact:</b> at 12:00 of the external reference corresponding to 11:59 on the internal WM50 clock <b>First displayed value:</b> at 11:45 for the interval from 11:30 (first integration interval multiple) to 11:45. <b>Note:</b> after synchronism contact, WM50 clock moves to 12:00:00 and the average value is updated with the value calculated between 11:45 and 11:59.

**Note:** function only available with M F I6 06 or M F I6 R4 accessory module. A digital input must be set with synchronization function.

**From WM50:** See "Settings from WM50" on page 31, sub-menu DMD.

### Total demand distortion calculation (TDD)

You can set the reference factor from UCS to calculate the current TDD, meaning the maximum current demand value absorbed by the load.



Tip: if available, indicate the maximum value between those measured, otherwise initially enter the rated load value.

## Voltage asymmetry calculation

The system calculates the phase-phase and phase-neutral voltage asymmetry dividing the total of the voltage maximum and minimum value by the system voltage. If voltages are all the same, asymmetry will be 0.

Following is the formula used:

$$AsyLL = \frac{V_{LLMax}(t_i) - V_{LLMin}(t_i)}{V_{LLsys}(t_i)}$$

$$AsyLN = \frac{V_{LNMax}(t_i) - V_{LNMin}(t_i)}{V_{LNsys}(t_i)}$$

## Filter

A filter can be set to stabilize the display of measurements (both on display and transmitted to external systems).

**Note:** the filter is applied to all measurements in read-only mode and for data transmission, without influencing calculations of energy consumption or intervention of alarms.

Two parameters are envisaged:

- filter intervention range. Value between 0 and 100, expressed as a percentage of the full scale of the variable.
- filter coefficient. Value between 1 and 255, where 255 is the coefficient that enables maximum stability of the measurements.

If the measured value is outside the set intervention range, the filter is not applied.





### Example

Following is filter behavior with:

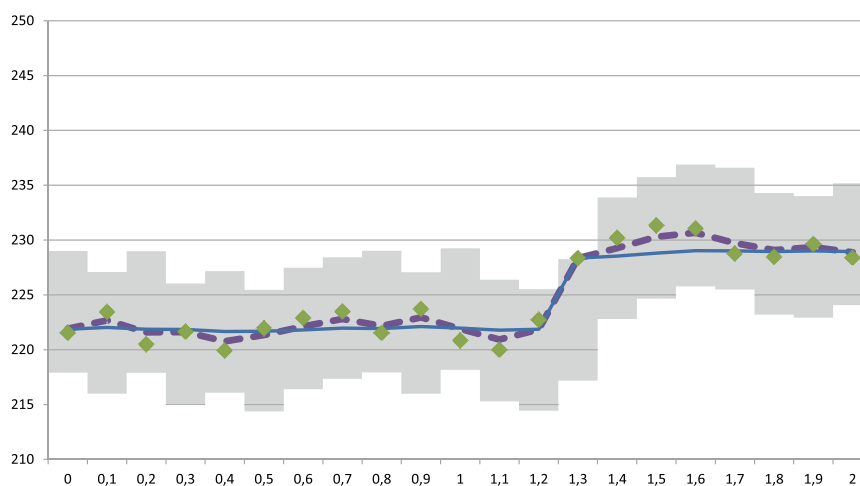
- range = 2
- coefficient = 2 or 10

The full scale is 277 V, therefore with range = 2 the intervention range is +/- 5.5 V (2% of 277 V). The higher the coefficient value, the higher the measurement stability.



Element	Description
	Intervention range = 2
	Measured value
	Measurements displayed with coefficient = 2
	Measurements displayed with coefficient = 10

**From WM50:** See "Settings from WM50" on page 31, sub-menu **Filter**.

# Alarms

## Introduction

WM50 manages:

- up to 16 independent alarms for the variables measured on the main line
- up to 96 channel alarms for a variable selected for advance channel monitoring (with different set points for each channel)
- up to 48 alarms for a variable selected for advance load monitoring (with different set points for each load)

## Alarm settings for main line variables

The following parameters must be set for each alarm:

- enable alarm
- variable to be monitored
- alarm type: up, down, out of window, in window (see “Alarm types” below)
- set 1: alarm activation threshold
- set 2: alarm deactivation threshold
- alarm activation delay
- start-up condition management mode (see “Start-up condition management” on page 25)
- alarm retention, latch function (see “Latch function” on page 25)
- any associated digital output and activation logic in the event of several alarms associated with the same output (see “Output activation logic” on page 25)

**Note:** the associated digital output must be set with **Alarm** function in the relevant settings.

## Alarm settings for channel or load variables

**Note:** alarms only concern the variable selected for advanced channel/load monitoring.

The following parameters must be set for the alarm:

Parameter type	Parameters
Shared by all channels/loads	<ul style="list-style-type: none"> <li>• General function enable</li> <li>• Alarm type: up, down, out of window, in window (see “Alarm types” below)</li> <li>• Alarm activation delay</li> <li>• Start-up condition management mode (see “Start-up condition management” on page 25)</li> <li>• Alarm retention, latch function (see “Latch function” on page 25)</li> </ul>
Specific to each channel/load	<ul style="list-style-type: none"> <li>• Single alarm enable</li> <li>• Set 1: alarm activation threshold</li> <li>• Set 2: alarm deactivation threshold</li> </ul>

## Alarm types

### Up alarm

The alarm is activated when the monitored variable exceeds the Set 1 value for a time equal to the activation delay (**Delay**) and is deactivated when it drops under Set 2 (if the latch function is not on).

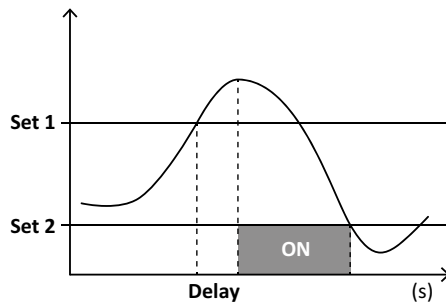



**Down alarm**

The alarm is activated when the monitored variable drops under the Set 1 value for a time equal to the activation delay (**Delay**) and is deactivated when it exceeds Set 2 (if the latch function is not on).

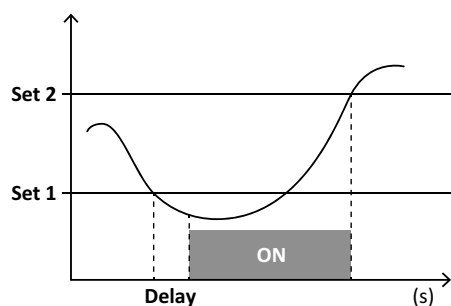
**Alarm in window**

The alarm is activated when the monitored variable remains between Set 1 and Set 2 for a time equal to the activation delay (**Delay**) and is deactivated when it is not in this range (if the latch function is not on).

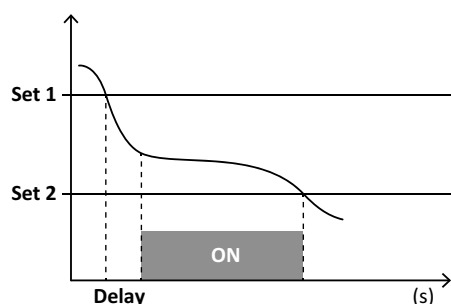
**Alarm out of window**

The alarm is activated when the monitored variable exits Set 1 and Set 2 range for a time equal to the activation delay (**Delay**) and is deactivated when it returns within this range (if the latch function is not on).

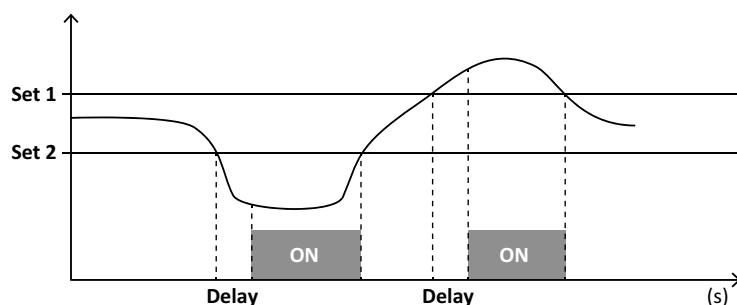
**Start-up condition management**

Alarm behavior can be set if the variable alarm is active at start-up. The alarm condition can be:

- considered and thus the alarm is immediately activated
- ignored and the variable is only monitored after the first time it exits the alarm condition

**Latch function**

When the latch function is enabled, the alarm remains active even if the monitored variable exits the alarm condition. The alarm can only be reset by the digital input or UCS command.

**Output activation logic**

If several alarms are associated with an output, the output will only activate if all the alarms set with AND logic are active or if at least one of the alarms set with OR logic is active.

## Setting alarms

To set an alarm for....	Then...	WM50 keypad	UCS
a main line or M A TPN analog input variable	set: <ul style="list-style-type: none"> <li>variable to be monitored = the desired variable</li> <li>all other parameters at will</li> </ul>	<b>x</b>	<b>x</b>
wrong voltage connection condition	set: <ul style="list-style-type: none"> <li>variable to be monitored = PHS (phase sequence)</li> <li>alarm type = down</li> <li>set 1 = 0</li> <li>set 2 = 0</li> </ul>	<b>x</b>	<b>x</b>
single channel or load alarms <i>Note: the alarm will activate if alarms were set and at least one of the channels or loads are in alarm conditions.</i>	set: <ul style="list-style-type: none"> <li>variable to be monitored = BCM</li> </ul>	<b>x</b>	<b>x</b>
variable selected for the single channels or loads	<ol style="list-style-type: none"> <li>Select the variable for advanced channel/load monitoring.</li> <li>Set parameters shared by all alarms.</li> <li>Enable and set the set point for each single channel or load.</li> </ol>	-	<b>x</b>

**From WM50:** See "Settings from WM50" on page 31, sub-menu **Virt al x** (x = alarm number).

## Accessory modules

### Enabling accessory modules

Accessory modules are automatically recognized by WM50. They only need to be manually set if configuring the system from UCS in offline mode.

**Note:** by default, the M C 485 232 communication module is always enabled even if not actually connected.

### Digital inputs

Digital inputs can run various functions, according to the following table:

Input	Possible functions
1	<ul style="list-style-type: none"> <li>Tariff</li> <li>Interval synchronization for average value calculation (dmd)</li> <li>Input status reading</li> </ul>
2	<ul style="list-style-type: none"> <li>Tariff</li> <li>Input status reading</li> </ul>
3	<ul style="list-style-type: none"> <li>Tariff</li> <li>Exported active energy meter pulse counting (kWh-)</li> <li>Input status reading</li> </ul>
4	<ul style="list-style-type: none"> <li>C1 totalizer pulse counting (water, gas, heat)</li> <li>C1 totalizer pulse counting (protection trip)</li> <li>Imported active energy meter pulse counting (kWh+)</li> <li>Alarm reset</li> <li>Input status reading</li> </ul>

Input	Possible functions
5	<ul style="list-style-type: none"> <li>C2 totalizer pulse counting (water, gas, heat)</li> <li>Imported reactive energy meter pulse counting (kvarh+)</li> <li>Input status reading</li> </ul>
6	<ul style="list-style-type: none"> <li>C3 totalizer pulse counting (water, gas, heat)</li> <li>Input status reading</li> </ul>

### Notes on digital inputs

To manage tariffs via digital inputs, all three inputs must run the tariff function, see "Tariff management" on page 27.

Inputs with pulse counting function for the energy meter replace calculated (voltage and current measurement) energy meters (total, partial and tariff).

The pulse weight must be set for inputs with counting function. The type must also be set for inputs with water, gas, heat count function.

**From WM50:** See "Settings from WM50" on page 31, sub-menu **Dig in x**.

## Digital outputs

Each digital output can run one of the following functions:

Function	Description	Parameters
Alarm	Output associated with one or more of the 16 virtual alarms managed by the main unit	Status of the digital output in non-alarm status
Remote	Output status managed via Modbus	-
Pulse output	Pulse transmission output on active or reactive, imported or exported energy consumption. Only from WM50, a pulse transmission test can be run, see "Running a pulse transmission test" on page 34.	<ul style="list-style-type: none"> <li>• Energy type</li> <li>• Pulse weight</li> <li>• Enable of transmission test</li> <li>• Power value for test</li> </ul>

*From WM50: See "Settings from WM50" on page 31*

## Tariff management

### Tariff management mode

Tariffs can be managed:

- via Modbus command
- via internal calendar and clock
- via digital inputs

### Managing tariffs via Modbus command

1. Set tariff management via Modbus command.
2. Change the tariff by entering the value corresponding to the current tariff according to the following table in the **143Fh** registry:

Current tariff	Register value
1	0
2	1
3	2

Current tariff	Register value
4	3
5	4
6	5

### Managing tariffs via internal calendar and clock

**Note:** this operation requires UCS desktop use.

1. Set tariff management via internal calendar and clock.
2. Set the date and time.
3. From UCS desktop, set the tariff calendar, setting:
  - default tariff to be applied for the periods when no tariff is set
  - weekends and the relevant tariff
  - tariff to be applied on working days (up to six daily intervals, for two periods)
  - current year holidays, manually or automatically set

### Managing tariffs via digital input

1. Set tariff management via digital input.
2. Set digital inputs 1, 2 and 3 with tariff function.
3. Change the tariff by changing the input status according to the following table (0 = open contact, 1 = closed contact):

Current tariff	Digital input 1	Digital input 2	Digital input 3
1	0	0	0
2	1	0	0
3	0	1	0

Current tariff	Digital input 1	Digital input 2	Digital input 3
4	1	1	0
5	0	0	1
6	1	0	1

## Disabling tariff management

Set tariff management as disabled or enter 6 in the **143Fh** register.

*From WM50: See "Settings menu" on page 19, sub-menu **Tariff** and **Dig in x**.*

## Database

### Introduction

Database can be exported to .xls file and databases and single variables, events and values to be saved can be enabled/disabled from UCS.



**CAUTION!** if database settings are changed, previously saved data is deleted.

### Database content

Database	Description	Data recorded for each record
Main line electrical variables	Recording of minimum, maximum and average values of main line variables selectable by the user.	<ul style="list-style-type: none"> <li>Record ID</li> <li>Time stamp *</li> <li>Type (min, max, average)</li> <li>Variable</li> <li>Value</li> </ul>
Main unit events	Recording of main unit events and alarms	<ul style="list-style-type: none"> <li>Record ID</li> <li>Time stamp *</li> <li>Type (on, off, configuration change, programming login, new minimum, maximum, maximum among average values reached, value reset, meter/totalizer reset, database reset, digital input/output status change)</li> <li>Variable associated with the event</li> </ul>
TCD12 events	Recording of TCD12 events and alarms	<ul style="list-style-type: none"> <li>Record ID</li> <li>Time stamp *</li> <li>Type (single channel alarm, load alarm, TCD12 configuration change or load configuration change)</li> <li>Other information according to event type: <ul style="list-style-type: none"> <li>single channel alarm: channel alarm</li> <li>load alarm: load alarm</li> <li>TCD12 configuration change: set channel, phase pattern and associated phase, selected advanced monitoring variable, energy meter reset and/or minimum and maximum values</li> <li>load configuration change: set load, selected advanced monitoring variable</li> </ul> </li> </ul>
TCD12 daily maximums/minimums	Recording of TCD12 variable daily minimum and maximum values set in advanced monitoring	<ul style="list-style-type: none"> <li>Record ID</li> <li>Time stamp *</li> <li>Value</li> </ul> <p><i>Note: if the date and time are changed, the saved values are deleted.</i></p>

**Note** \*: to record time stamp information in the databases, the analyzer date and time must be set.

## Date and time

### Settings

The date and time can be set either via WM50 keypad or UCS.



**CAUTION!** If the average value calculation interval synchronization (dmd) is enabled via internal clock, changing the time clears the interval and sets the average values as not available until the end of the first interval.



**CAUTION!** Changing the time clears the daily minimum and maximum values from the database.

### Daylight savings time

The following is possible with UCS:

- disable daylight savings time management.
- set automatic time change. Select the time zone in which the analyzer is installed and UCS saves the time change rule in the analyzer for the next 20 years. The user must update the rule in the event of governmental change after first configuration.

## LCD display

### Back lighting

The backlight time, color and behavior in the event of alarm can be set.

**Note:** if the alarm is active, blinking is only visible in the measurement menu and not in settings and information menus.

---

**From WM50:** See "Settings menu" on page 19, sub-menu **Backlight** and **Color**.

---

### LCD bar graph

The bar graph in the measurement pages (see "Measurement menu display" on page 11) can display the current active or apparent current value. The value is expressed as a percent of the set full range.

---

**From WM50:** See "Settings menu" on page 19, sub-menu **SET POWER**.

---

### Home page

The measurement page displayed by default when the analyzer is turned on or after 120 s of disuse can be set. The home page can be selected from the default pages or customized row by row.

---

**From WM50:** See "Settings menu" on page 19, sub-menu **Home page**.

---

## TCD12

### TCD12 identification

TCD12 configured and connected to WM50 is identified by the system via the combination of its three features:

- serial number (on the top of the sensor)
- physical position on the TCD bus (i.e.: A1 for TCD A bus TCD12 closest to WM50)
- monitored channel group

The physical position and channel group are set in the configuration phase. The serial number is read and automatically associated when the system detects it in the position indicated in configuration when connected with WM50.

# Configure the system

## Configure WM50

### Configuration mode

The configuration modes for each component are provided below:

Component	WM50 keypad	UCS desktop	UCS Mobile
Main unit	x (excluding daylight savings time, tariff calendar and database)	x	x (excluding tariff calendar and database)
Accessory modules	x	x	x
TCD12	-	x	x

### Configuration requirements via UCS

To configure the system with UCS:

- Acquire a PC or smartphone with one of the following applications installed:

Application	Compatibility	Where to find it
UCS Mobile	Smartphone Android	Google Play Store
UCS Desktop	PC Windows 7 or later	<a href="http://www.productselection.net/Download/UK/ucs.zip">www.productselection.net/Download/UK/ucs.zip</a>

- Equip WM50 with one of the following communication interfaces:

Component	Compatibility	Description
MCETH	UCS desktop UCS Mobile	Modbus TCP/IP communication module
MC485232	UCS desktop	Modbus RTU communication module
OptoProg	UCS desktop UCS Mobile	Optical interface for Bluetooth or USB communications

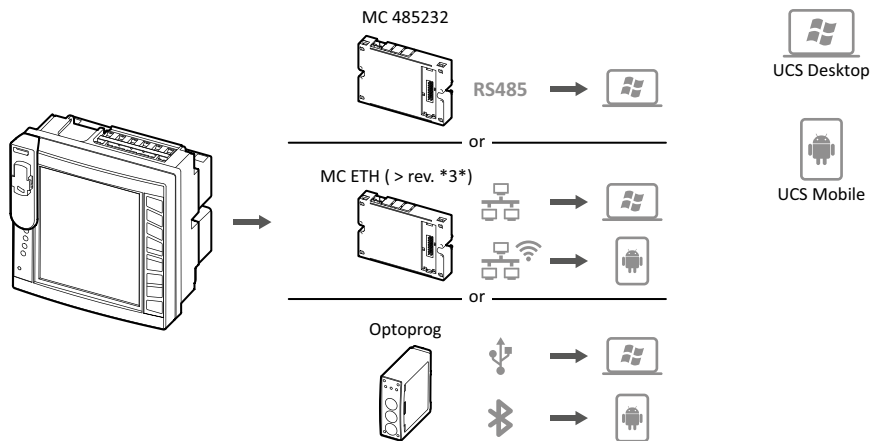

### Configuring WM50 via touch keypad

- Open the settings menu.
- Set parameters and save.

To learn how to interact with WM50, see “WM50 use” on page 11.

To learn more about settings pages, see “Settings from WM50” on page 31.

### Configuring WM50 via PC or smartphone

**Note:** communication parameters may need to be set via touch keypad to communicate with WM50.

- Meet all the requirements indicated in “Configuration requirements via UCS” before.
- Follow the instructions according to how you want the analyzer and PC/smartphone to communicate:

To communicate...	Then...
via RS485 network (Modbus RTU) or Ethernet (Modbus TCP/IP)	set WM50 communication parameters via touch keypad
via direct point to point connection or via OptoProg	skip to the next step

3. Start UCS and connect to WM50 via automatic scan or by manually setting correct communication parameters.
4. Open the settings section, set parameters and save changes.
5. Check correct system operations using the data display and read tools included in UCS.

## Settings from WM50

### General settings



**CAUTION!** The settings menu automatically closes after 120 s of disuse and all changes are lost.

**Note:** default values are underlined. Presence of the pages depends on the installed accessory modules, see "Accessory modules settings" on page 34. To learn more about settings, see "Essential information" on page 21.

Page title/sub-menu	Page title	Description	Values
<b>Password?</b>	-	Enter current password	Current password
<b>Change pass</b>	-	Change password	Four digits (from <u>0</u> to 9999)
<b>Backlight</b>	-	Display backlight time (min)	0: always on From 1 to 255 ( <u>2</u> )
<b>Color</b>	-	Back lighting	<u>0</u> : off <b>1</b> : white <b>2</b> : blue <b>3</b> : blinking if an alarm is active, otherwise off <b>4</b> : blinking if an alarm is active, otherwise white <b>5</b> : blinking if an alarm is active, otherwise blue
<b>Modules</b>	<b>MF16O6</b> <b>MF16R4</b> <b>MATPN</b> <b>MC485232</b> <b>MCETH</b>	Module enable	<b>Yes/ No</b> <b>Auto</b> : indicates that the module is automatically recognized by the system
	<b>MABC</b>	Enable LED ON blinking of TCD12 that monitors the set channels	<b>1.12</b> : channels from 1 to 12 <b>13.24</b> : channels from 13 to 24 <b>25.36</b> : channels from 25 to 36 <b>37.48</b> : channels from 37 to 48 <b>49.60</b> : channels from 49 to 60 <b>61.72</b> : channels from 61 to 72 <b>73.84</b> : channels from 73 to 84 <b>85.96</b> : channels from 85 to 96
<b>System</b>	-	System type	<b>1P</b> : single-phase system (2-wire) <b>2P</b> : two-phase system (3-wire) <b>3P.n</b> : three-phase system (4-wire)
<b>Ct ratio</b>	-	Current transformer ratio (CT)	From <u>1</u> to 2000
<b>Ctn ratio</b>	-	Neutral current transformer ratio	From <u>1</u> to 9999
<b>Dmd</b>	<b>Time</b>	Average values calculation interval (min)	<b>1/ 5/ 10/ <u>15</u>/ 20/ 30/ 60</b>
	<b>Sync</b>	Synchronization type for average value calculation	<b>Off</b> : synchronization disabled <b>CloC</b> : via internal clock <b>inP</b> : via internal clock synchronized via digital input
<b>Set power</b>	<b>Type</b>	Power displayed in the LCD bar graph	<b>VA</b> : apparent power <b>W</b> : active power
	<b>Value</b>	Full range (W or VA)	From <u>1000</u> to 9999M

## Configure the system

Page title/sub-menu	Page title	Description	Values
Home page	<b>Type</b>	Measurement page type displayed on access to measurement menu and after 120 s of inactivity	<b>VARs</b> : row by row customized page <b>PAGE</b> : default page
	<b>Page</b>	With <b>Type</b> = <b>PAGE</b> , default page selected	The available measurement pages, recognizable via the units of measure for
	<b>Line 2</b>	With <b>Type</b> = <b>VARs</b> , variable according to row selected	Managed variable selection
	<b>Line 3</b>	With <b>Type</b> = <b>VARs</b> , third row variable selected	Managed variable selection
	<b>Line 4</b>	With <b>Type</b> = <b>VARs</b> , fourth row variable selected	Managed variable selection
	<b>Line 5</b>	With <b>Type</b> = <b>VARs</b> , fifth row variable selected	Managed variable selection
Filter	<b>Filter s</b>	Interval of filter intervention with respect to full scale (%)	From 0 to 100 (2)
	<b>Filter co</b>	Filter coefficient	From 1 to 256 (2)
Optical	<b>Baudrate</b>	Baud rate (kbps)	<b>9.6/ 19.2/ 38.4/ 115.2</b>
	<b>Parity</b>	Parity	<b>None/ Odd/ Even</b>
RS485232	<b>Address</b>	Modbus address	From 1 to 247
	<b>Baudrate</b>	Baud rate (kbps)	<b>9.6/ 19.2/ 38.4/ 115.2</b>
	<b>Parity</b>	Parity	<b>None/ Odd/ Even</b>
Ethernet	<b>IP add</b>	IP address	From 0.0.0.0 to 255.255.255.255 ( <b>192.168.0.1</b> )
	<b>Subnet</b>	Subnet mask	From 0.0.0.0 to 255.255.255.255 ( <b>255.255.255.0</b> )
	<b>Gateway</b>	Gateway	From <b>0.0.0.0</b> to 255.255.255.255
	<b>TCP IP Prt</b>	TCP/IP port	From 1 to 9999 ( <b>502</b> )
Virtual x (x = alarm number)	<b>Enable</b>	Enable of alarm x	<b>Yes/ No</b>
	<b>Variables</b>	Variable controlled by the alarm	All managed real-time variables
	<b>Type</b>	Alarm type	<b>up</b> : up alarm <b>down</b> : down alarm <b>in</b> : alarm in window <b>out</b> : alarm out of window
	<b>Latch</b>	Alarm retention enabled	<b>Yes/ No</b>
	<b>Start cond</b>	Behavior if in alarm conditions at start-up	<b>Yes</b> : does not signal the alarm <b>No</b> : signals the alarm
	<b>On delay</b>	Alarm activation delay (s)	From 0 to 3600
	<b>Set 1</b>	Alarm activation threshold or upper window limit	The unit of measurement and range of admissible values depend on the controlled variable.
	<b>Set 2</b>	Alarm deactivation threshold or lower window limit	
	<b>Out link</b>	Associated digital output	0: no output associated From 1 to 6
	<b>Out logic</b>	Output activation logic	<b>AND/ OR</b>
Digital output x (x = output number)	<b>Function</b>	Function of digital output x	<b>Remo</b> : remote control <b>Alar</b> : alarm <b>Puls</b> : pulse output
	<b>Pulse type</b>	Type of energy (kWh or kvarh)	<b>kWh Pos</b> : imported active energy/ <b>kvarh Pos</b> : imported reactive energy/ <b>kWh Neg</b> : exported active energy/ <b>kvarh Neg</b> : exported reactive energy
	<b>Pulse weig</b>	Weight of pulse (kWh/kvarh per pulse)	-
	<b>AI status</b>	Normal output status	<b>Ne</b> : normally closed/ <b>Nd</b> : normally open
	<b>Out test</b>	Enable of transmission test	<b>Yes/ No</b>
	<b>Power test</b>	Power value for test	From 0.001 W to 9999 MW
Tariff	-	Tariff management	<b>none</b> : disabled <b>Cloc</b> : via internal calendar and clock <b>Inp</b> : via digital inputs <b>Remo</b> : via Modbus command



Page title/sub-menu	Page title	Description	Values
<b>Dig in x</b> (x = input number)	<b>Function</b>	Digital input x function	<b>remo</b> : input read status <b>Tari</b> : tariff management <b>Puls</b> : pulse totalizer <b>Rst</b> : alarm reset <b>Trip</b> : protection trip totalizer <b>Sync</b> : average value calculation interval synchronization command (dmd) <b>Cont</b> : pulse meter associated with total imported, exported or imported reactive energy according to the selected input  <b>IMPORTANT</b> : check which functions are available for each input, see "Digital inputs" on page 26
	<b>Pulse type</b>	Value associated with the pulse totalizer for <b>Puls</b> selection	<b>Gas</b> : gas <b>H2OC</b> : cold water <b>H2OH</b> : hot water <b>HEAT</b> : heat
	<b>Pulse weig</b>	Pulse weight	From 0.001 to 9999 Value expressed in kWh, kvarh, m3 or number of trips per pulse
<b>Process</b>	<b>Unit</b>	Temperature unit of measure	<b>C</b> : degrees Celsius <b>F</b> : degrees Fahrenheit
	<b>Probe</b>	Temperature probe type	<b>0</b> : PT100 (3-wire) <b>1</b> : PT100 (2-wire) <b>2</b> : <u>PT1000 (3-wire)</u> <b>3</b> : PT 1000 (2-wire)
	<b>Min elect</b>	Minimum analog input value	From - 20mA to 20 mA
	<b>Max elect</b>	Maximum analog input value	From - 20mA to 20 mA
	<b>Min displ</b>	Value displayed for minimum analog input	From -9999 to 9999M
	<b>Max displ</b>	Value displayed for maximum analog input	From -9999 to 9999M
<b>Meters</b>	<b>Total</b>	Resets main line total energy meters	<b>Yes</b> : resets values/ <b>No</b> : no action
	<b>Partial</b>	Resets partial energy meters	
	<b>Total +</b>	Resets total positive energy meters	
	<b>Total -</b>	Resets total negative energy meters	
	<b>Partial +</b>	Resets partial positive energy meters	
	<b>Partial -</b>	Resets partial negative energy meters	
	<b>Tariff</b>	Resets tariff energy meters	
	<b>Heating</b>	Resets C1, C2, C3 pulse totalizers with <b>Puls</b> function	
	<b>Trip</b>	Resets C1 totalizer with protection trip function	
<b>Reset</b>	<b>Reset max</b>	Resets maximum values	<b>Yes</b> : resets values/ <b>No</b> : no action
	<b>Reset DMD</b>	Resets DMD values	
	<b>Reset DMax</b>	Resets Max DMD values	
	<b>Reset MIN</b>	Resets minimum values	

## Configure the system

Page title/sub-menu	Page title	Description	Values
Clock	Format	Time format	Eu: European uSA: American
	Year	Year	Up to 2099
	Month	Month	From 1 to 12
	Day	Day	From 1 to 31
	Hour	Hour	From 0 to 23
	Minute	Minute	From 0 to 59
	Second	Second	From 0 to 59
End	-	Saves changes and returns to measurement menu	-

## Accessory modules settings

Accessory module	Sub-menu/Page
M A TPN	Ct ratio Process
M F I6 06	Dig in x
M F I6 R4	Dig out x
M C 485 232	RS485232
M C ETH	Ethernet

## Running a pulse transmission test

**Note:** function only available from WM50.

If a digital output is configured as a pulse output, a pulse transmission test can be run.

1. In the settings menu, open the **Dig out x** sub-menu (where x is the concerned digital output).
2. Ensure that the output is configured for pulse transmission (**Function = Puls**).
3. Define the pulse weight (**Pulse weig**) and test power (**Power test**).
4. To start the test, in the **Out test** page, set **Yes**.
5. Exit the **Dig out x** sub-menu and scroll settings to the **End** page and confirm exit: the test starts.
6. To end the test, open the **Dig out x** sub-menu, **Out test** page and set **No**.

## Checking accessory module enabling

You can check whether modules are enabled from WM50 settings menu in sub-menu **Modules**. "Auto" means that the module is automatically recognized and its status can no longer be changed.

## Configure TCD12s

### Configure TCD12 layout connected to WM50

**Note:** function only available via UCS.

1. Meet all the requirements indicated in "Configuration requirements via UCS" on page 30.
2. Start UCS.
3. Follow the instructions depending on how you want to configure:

If...	Then...
you want to create an offline configuration	1. Create an offline configuration. 2. Open TCD12 settings.
you want to directly change settings	1. Connect to WM50. 2. Open TCD12 settings.

4. Select the layout that represents the physical TCD12 positions.
5. Select TCD12s connected to port A (TCD A bus) and those connected to port B (TCD B bus) in the order they are connected to WM50 (i.e.: A1 for TCD A bus TCD12 closest to WM50).
6. Assign a channel group to each TCD12: group 1-12 is assigned to the first selected, group 13-24 to the second and so on.

7. Select each TCD12:
  - rotate it or reverse the channel order, if necessary (by default, the first channel is the one identified on TCD12, see “TCD12” on page 29).
  - check/assign the correct phase to each channel.
  - optional. Create load groups.
8. Save changes.
9. If necessary, download the configuration on WM50 and check settings, see “TCD12 LED status” on page 9 and “Troubleshooting” on page 38.

## Moving a TCD12

If TCD12 position on the TCD bus changes, the system recognizes it: from UCS, view the warning on the involved TCD12. The configuration must be reset accordingly.

## Replacing a TCD12

If a TCD12 is replaced, the system indicates that the newly connected TCD12 is not expected and the **BCM** LED blinks on the main unit. The configuration must be reset: the system will associate the physical position serial number and channel group that used to be associated with the replaced TCD12 to the new one.

# Other operations

---

## Manage alarms

### Reset an alarm via digital input

**Note:** function only available with M F I6 06 or M F I6 R4 accessory module.

1. Set digital input 4 as remote reset alarm.
2. Close the digital input 4 contact.

**Note:** the alarm is only deactivated if the alarm condition no longer exists, otherwise the command has no effect. The command only affects main line and M A TPN variable alarms.

---

**From WM50:** Sub-menu **Dig in 4**, page **Function = Rst**.

---

### Reset an alarm via UCS

1. Connect WM50 to UCS.
2. In settings, open the reset section and send the concerned command (main line and M A TPN variable alarms or TCD12 alarms).

**Note:** the alarm is only deactivated if the alarm condition no longer exists, otherwise the command has no effect.

### Recognize active alarms

Active alarms can be recognized as follows:

- at the single alarm level, in the specific UCS section.
- on the alarm group level, by WM50 **G1**, **G2**, **G3**, **G4** LED status, see “Main unit LED status” on page 7



Tip: to set up to four alarms only, associate them with virtual alarm 1, 5, 9 and 13. This way, the **G1**, **G2**, **G3** and **G4** LEDs turn on to indicate whether the single alarm is active.

**Note:** the alarm also activates if the variable measurement is not available.

## Reset meters and values

### Reset energy meters and totalizers

Energy meters for the main line and totalizers can be reset from both WM50 and UCS. TCD12 energy meters can only be reset from UCS.

---

**From WM50:** See “Settings from WM50” on page 31, sub-menu **Meters**.

---

#### From WM50

In the settings menu, sub-menu Meters select the page for the meter/totalizer to be reset. See “Settings from WM50” on page 31, sub-menu **Meters**.

#### From UCS

1. Connect WM50 to UCS.
2. In settings, open the reset section.

### Reset minimum, maximum, dmd and max dmd values

Minimum, maximum, average (dmd) and maximums among averages (max dmd) values can be reset for the main line from both WM50 and UCS.

Daily minimum and maximum values and real-time minimum, maximum and average values for the single channels and loads can only be reset via serial communication.

**From WM50**

To reset...	Then...
all variable values	in the settings menu, in sub-menu <b>Reset</b> select the page for the values to be reset
values concern only the variables in a measurement page	in the variable measurement page to reset values: <ul style="list-style-type: none"> <li>press and hold down (1.5 s) the key ▲ or ▼.</li> <li>scroll the pages until the values to be reset are displayed and confirm.</li> </ul>

**From UCS**

1. Connect WM50 to UCS.
2. In settings, open the reset section.

## Communicating with other devices

### Communicated via M C ETH module

1. Make sure the module is correctly installed.
2. Set network parameters via WM50 keypad or from USC mobile connected with OptoProg.
3. Connect WM50 to the master via Ethernet cable to the LAN or directly (point to point connection).
4. Create communications via mater (PC, VMU-C, PLC, etc.) connected to the same LAN or connected point to point.

**Note:** the module starts to communicate about 15-30 s after WM50 is turned on.

### Communicated via M C 485 232 module

1. Make sure the module is correctly installed.
2. If necessary, set serial communication parameters via WM50 keypad or from USC mobile connected with OptoProg.
3. Connect WM50 to the master.
4. Create communications via master (PC; VMU-C, PLC, etc.).

### Communicate via OptoProg

See relevant instruction manual.

# Maintenance and disposal

## Troubleshooting

**Note:** in the event of malfunction or fault, contact the CARLO GAVAZZI branch or distributor in your country.

### Measurement problems

Problem	Cause	Possible solution
'EEEE' (on WM50) or "--" (on UCS) appears instead of the measurement	The current transformer settings are not correct and therefore the measurement exceeds the maximum admissible value, or is the result of calculations with at least one measurement error.	Change the current transformer ratio
	The analyzer is not used within the expected measurement range and therefore the measurement exceeds the maximum admissible value, or is the result of calculations with at least one measurement error.	Uninstall the analyzer
	The analyzer has just been switched on and the set interval for calculating the average power values (default: 15 min) has not yet elapsed.	Wait. If required, change the integration interval.
Frequency and voltage values are zero	No data received from the phase used to calculate frequency	Check line status and analyzer connections, see WM50 installation instructions
The values displayed are not as expected	Electrical connections are incorrect	Check line status and analyzer connections, see WM50 installation instructions
	The current transformer settings are incorrect	Check the set current transformer ratio value
	There are more than four TCD12s per TCD bus	Check TCD bus composition and reorganize TCD12 buses
The values displayed differ from those expected and G1, G2, G3, G4 LEDs blink	TCD12 configuration error	From UCS check the configuration

### Alarms

Problem	Cause	Possible solution
An alarm has activated but the measurement has not exceeded the threshold	The value used to calculate the alarm variable is in error conditions	Check the set current transformer ratio value
	The analyzer is not used within the expected measurement range	Uninstall the analyzer
The alarm is not activated or deactivated as expected	The alarm settings are incorrect	Check set parameters. Check measured value consistency with analyzer features

### Communication problems

Problem	Cause	Possible solution
Communication not possible with analyzer	The communication module/OptoProg settings are incorrect	Check set parameters.
	The communication module/OptoProg connections are incorrect	Check connections, see accessory module manual
	Communication device settings (PLC or third party software) are incorrect	Check communication with UCS

### Problems during settings

Problem	Cause	Possible solution
'Err' appears while the parameter is being set	The value entered is out of range	Check the admissible value range and enter the correct value.
It is impossible to change the settings (via keypad)	The password entered is incorrect	Enter the correct password

Problem	Cause	Possible solution
It is impossible to change the settings (via UCS)	WM50 is displaying the settings menu or information menu	Return to measurement menu

## LED

See "Main unit LED status" on page 7 and "TCD12 LED status" on page 9.

## Cleaning

Use a slightly dampened cloth to clean the display. Do not use abrasives or solvents.

## Responsibility for disposal



The product must be disposed of at the relative recycling centers specified by the government or local public authorities. Correct disposal and recycling will contribute to the prevention of potentially harmful consequences to the environment and persons.

# Features

## WM50 common specifications

### General features

Material	Front: ABS, self-extinguishing V-0 (UL 94); PC, self-extinguishing V-2 (UL 94) Back and accessory modules: PA66, self-extinguishing V-0 (UL 94)
Protection degree	Front: IP65 NEMA 4x NEMA 12 Terminals: IP20
Overvoltage category	Cat. III
Measurement category	Cat. III
Pollution degree	2
Noise rejection (CMRR)	100 dB, from 42 to 62 Hz
MTBF/MTTF	Minimum 80 years*
Insulation	 double electrical insulation on areas accessible to the user. For insulation between inputs and outputs, see "Input and output insulation" below.

### Environmental specifications

Operating temperature	From -25 to +40 °C/from -13 to +104 °F
Storage temperature	From -30 to +70 °C/from -22 to +158 °F

**Note:** R.H. < 90 % non-condensing @ 40 °C / 104 °F.

\*Calculated according to Siemens SN 29500, taking into consideration the following condition: mean ambient temperature: 50 °C.

### Input and output insulation

Type	Power supply	Voltage measurement inputs	Current measurement inputs	Digital outputs/inputs	Analog inputs	Serial port	Ethernet port	TCD12 bus port	Functional ground connector
Power supply	-	Basic	Basic	Double	Double	Double	Double	Basic	Basic
Voltage measurement inputs	Basic	-	Basic	Double **	Double **	Double **	Double **	Basic	Basic
Current measurement inputs	Basic	Basic	-	Double	Double	Double	Double	Double	Basic
Digital outputs/inputs	Double	Double **	Double	-	NP	Double	Double	Basic	Basic
Analog inputs	Double	Double **	Double	NP	-	Double	Double	Basic	Basic
RS485 serial port	Double	Double **	Double	Double	Double	-	NP	Basic	Basic
Ethernet port	Double	Double **	Double	Double	Double	NP	-	Basic	Basic
TCD12 bus port	Basic	Basic	Basic	Basic	Basic	Basic	Basic	-	Basic
Functional ground connector	Basic	Basic	Basic	Basic	Basic	Basic	Basic	Basic	-

**NP:** combination not possible. **Note \*\*:** 2.5 kV ac 1 min (4 kV pk 1.2/50 μs) and limiting impedance.

## Main unit specifications

### Electrical specifications

#### Electrical system

Managed electrical system	<ul style="list-style-type: none"> <li>Single-phase (2-wire)</li> <li>Two-phase (3-wire)</li> <li>Three-phase (4-wire)</li> </ul>
---------------------------	---

#### Voltage inputs

Voltage connection	Direct
VT/PT transformation ratio	-
Rated voltage L-N (from Un min to Un max)	From 120 to 277 V
Rated voltage L-L (from Un min to Un max)	From 208 to 480 V
Voltage tolerance	-20%, + 15%
Overload	Continuous: 1.2 Un max For 500 ms: 2 Un max
Input impedance	>1.6 MΩ
Frequency	50/60 Hz

#### Current inputs

Current connection	Via CT
CT transformation ratio	From 1 to 2000
Rated current (In)	5 A
Minimum current (Imin)	0.05 A
Maximum current (Imax)	6 A
Start-up current (Ist)	5 mA
Overload	Continuous: Imax For 500 ms: 20 Imax
Input impedance	< 0.2 VA

#### Power supply

Auxiliary power supply	From 100 to 277 V ac/dc ± 10%
Consumption	≤20 VA (approx), 9 W(dc)



### Main line measurement precision (main unit)

Current	
From 0.05 In to I <sub>max</sub>	±(0.2% rdg + 2dgt)
From 0.01 In to 0.05 In	±(0.5% rdg + 2dgt)
Phase-phase voltage	
From Un min -20% to Un max + 15%	±(0.5% rdg + 1dgt)
Phase-neutral voltage	
From Un min -20% to Un max + 15%	±(0.2% rdg + 1dgt)
Active and apparent power	
From 0.05 In to I <sub>max</sub> (PF=0.5L, 1, 0.8C)	±(0.5% rdg + 1dgt)
From 0.01 In to 0.05 In (PF=1)	±(1% rdg + 1dgt)

Reactive power	
From 0.1 In to I <sub>max</sub> (sinφ=0.5L, 0.5C)	±(1% rdg + 1 dgt)
From 0.05 In to I <sub>max</sub> (sinφ=1)	
From 0.05 In to 0.1 In (sinφ=0.5L, 0.5C)	±(1.5% rdg + 1 dgt)
From 0.02 In to 0.05 In (PF=1)	
Power factor	±[0.001+0.5%(1 - PF rdg)]
Active energy	Class 0.5S (EN62053-22)
Reactive energy	Class 2 (EN62053-23)
THD	±1%
Frequency	
From 45 to 65 Hz	±0.1 Hz

### Channel and load measurement precision (TCD12)

Current	
From 0.1 lb to I <sub>max</sub>	±(0.5% rdg + 2dgt)
From 0.05 lb to 0.1 lb	±(1% rdg + 2dgt)
Active and apparent power	
From 0.1 lb to I <sub>max</sub> (PF=1)	±(2% rdg + 1dgt)
From 0.2 lb to I <sub>max</sub> (PF=0.5L, 0.8C)	
From 0.05 In to 0.1 lb (PF=1)	±(2.5% rdg + 1dgt)
From 0.1 lb to 0.2 lb (PF=0.5L, 0.8.5C)	

Reactive power	
From 0.1 lb to I <sub>max</sub> (sinφ=1)	±(3% rdg + 2 dgt)
From 0.2 lb to I <sub>max</sub> (sinφ=0.5L, 0.5C)	±(3% rdg + 1 dgt)
Power factor	±[0.001+0.5%(1 - PF rdg)]
Active energy	Class 2 (EN62053-21)
THD	±1%

### Optical port

Compatible accessories	OptoProg
Configuration parameters	<ul style="list-style-type: none"> <li>Baud rate (9,6/ 19,2/ 38,4/ 115,2 kbps)</li> <li>Parity (None/ Odd/ Even)</li> </ul>
Configuration mode	Via keypad or UCS

### Memory

<b>Main line electrical variable database</b>	Log interval: from 1 to 60 min Maximum number of records saved: from 10,000 to 260,000 according to the number of monitored variables Memory management: FIFO
<b>Main unit event database</b>	Number of events: 10 000 Memory management: FIFO
<b>TCD12 event database</b>	Number of events: 10 000 Memory management: FIFO
<b>Daily maximum/minimum database for each channel and load</b>	Log interval: daily Maximum number of records saved: 366 Memory management: FIFO

## Digital input/output module specifications

### M F I6 06 module features

#### Inputs

Number of inputs	6
Input type	Voltage free
Features	Open contact voltage: ≤ 3.3 V dc Closed contact voltage: < 1 mA dc Open contact resistance: ≥ 50 kΩ Closed contact resistance: ≤ 300 Ω
Configuration parameters	<ul style="list-style-type: none"> <li>Input function: remote input status reading/rate management/pulse counting/alarm rest/average value calculation interval synchronization (dmd)</li> <li>Pulse type and pulse weight ("pulse counting" function only)</li> </ul>
Configuration mode	Via keypad or UCS

#### Outputs

Number of inputs	6
Input type	Opto-mosfet
Features	V <sub>ON</sub> : 2.5 V dc, 100 mA max V <sub>OFF</sub> : 42 V dc max
Configuration parameters	<ul style="list-style-type: none"> <li>Output function: alarm/ remote control/ pulse</li> <li>Normal output status ("alarm" function only)</li> <li>Pulse weight, transmitted energy type, test transmission settings ("pulse" function only)</li> </ul>
Configuration mode	Via keypad or UCS

## Features

### M F I6 R4 module features

#### Inputs

Number of inputs	6
Input type	Voltage free
Features	Open contact voltage: $\leq 3.3$ V dc Closed contact voltage: $< 1$ mA dc Open contact resistance: $\geq 50$ k $\Omega$ Closed contact resistance: $\leq 300$ $\Omega$
Configuration parameters	<ul style="list-style-type: none"> <li>Input function: remote input status reading/rate management/pulse counting/alarm rest/average value calculation interval synchronization (dmd)</li> <li>Pulse type and pulse weight ("pulse counting" function only)</li> </ul>
Configuration mode	Via keypad or UCS

#### Outputs

Number of inputs	4
Input type	SPDT relay
Features	AC1: 5 A @ 250 V ac AC15: 1 A @ 250 V ac
Configuration parameters	<ul style="list-style-type: none"> <li>Output function: alarm/ remote control/ pulse</li> <li>Normal output status ("alarm" function only)</li> <li>Pulse weight, transmitted energy type, test transmission settings ("pulse" function only)</li> </ul>
Configuration mode	Via keypad or UCS

## Analog input module features

### M A TPN module input features

#### Analog input

Input type	From -20 to 20 mA dc
Accuracy	From 0% to 25% full scale: $\pm(0.2\%$ rdg + 2dgt) From 25% to 110% full scale: $\pm(0.1\%$ rdg + 2dgt)
Overload	Continuous: 50 mA dc For 1 s: 150mA dc
Temperature drift	$\leq 150$ ppm/ $^{\circ}$ C
Input impedance	$< 12$ $\Omega$
Configuration parameters	address, baudrate, odd, bit stop
Configuration mode	Via keypad or UCS

#### Temperature probe input

Probe type	Two or three-wire PT100 or PT1000
Measurement range	From -60 to 300 $^{\circ}$ C (from -76 to 572 $^{\circ}$ F) with PT100 probe; from -60 to 300 $^{\circ}$ C (from -76 to 572 $^{\circ}$ F) with PT1000 probe
Accuracy	$\pm(0,5\%$ rdg + 5dgt)
Compensation	Up to 10 $\Omega$
Temperature drift	$\leq 150$ ppm/ $^{\circ}$ C
Configuration parameters	address, baudrate, odd, bit stop
Configuration mode	Via keypad or UCS

#### Neutral current input

Rated current (In)	1 A
Accuracy	$\pm(0,5\%$ rdg + 2dgt) from 0.01 In to 0.05 In; $\pm(0,2\%$ rdg + 2dgt) from 0.05 In to 1.2 In.
Overload	Continuous: 1.2 In For 500 ms: 10 In
Temperature drift	$\leq 150$ ppm/ $^{\circ}$ C
Input impedance	0.5 $\Omega$
Configuration parameters	Current transformer ratio
Configuration mode	Via keypad or UCS

## Communication module features

### M C 485232 module

#### RS485 port

Protocol	Modbus RTU
Devices on the same bus	Max 160 (1/5 unit load)
Communication type	Multidrop, bidirectional
Connection type	2 wires, maximum distance 1000 m
Configuration parameters	
Configuration mode	Via keypad or UCS

#### RS232 port

Protocol	Modbus RTU
Communication type	Bidirectional
Connection type	3 wires, maximum distance 15 m
Configuration parameters	
Configuration mode	Via keypad or UCS

**NOTE:** the RS485 and RS232 ports are alternative.

#### LED

Meaning	Communication status: <ul style="list-style-type: none"> <li>Yellow: receiving</li> <li>Green: transmitting</li> </ul>
---------	--

## M C ETH module

### Ethernet port

Protocol	Modbus TCP/IP
Client connections	Maximum 5 simultaneously
Connection type	RJ45 connector (10 Base-T, 100 Base-TX), maximum distance 100 m
Configuration parameters	IP address, subnet mask, default gateway, TCP port
Configuration mode	Via keypad or UCS

## TCD12 current sensor features

### General features

Material	PPO, self-extinguishing V-0 (UL 94)
Protection degree	Front: IP50
Overvoltage category	Cat. III
Pollution degree	2
MTBF/MTTF	Minimum 80 years*
Insulation	60 s, 1500 V ca (with TCD12WS cables connected)
Power supply	Self power supply via TCD bus

### Environmental specifications

Operating temperature	From -25 to +40 °C/from -13 to +104 °F
Storage temperature	From -25 to +70 °C/from -22 to +158 °F

**Note:** R.H. < 90 % non-condensing @ 40 °C / 104 °F.

### Electrical specifications

Current connection	Bus cable
CT transformation ratio	-
Rated current (I <sub>n</sub> )	32 A
Base current (I <sub>b</sub> )	10 A
Minimum current (I <sub>min</sub> )	0.5 A
Maximum current (I <sub>max</sub> )	40 A
Start-up current (I <sub>st</sub> )	40 mA
Overload	Continuous: 2 I <sub>max</sub> For 500 ms: 20 I <sub>max</sub>
Input impedance	-

\*Calculated according to Siemens SN 29500, taking into consideration the following condition: mean ambient temperature: 50 °C.

## Conformity

Directives	<ul style="list-style-type: none"> <li>• 2014/35/EU (LVD - Low Voltage)</li> <li>• 2014/30/EU (EMC - Electro Magnetic Compatibility)</li> <li>• 2011/65/EU (RoHS - Electric-electronic equipment hazardous substances)</li> </ul>
Standards	<ul style="list-style-type: none"> <li>• Electromagnetic compatibility (EMC) - emissions and immunity:</li> <li>• Electrical safety: EN61010-1</li> <li>• Metrology: EN62053-22, EN62053-23</li> <li>• Pulse outputs: IEC62053-31, DIN43864</li> </ul>
Approvals	

## Part numbers key

### Main unit part number (rear of unit)

WM50	AV5	3	H	BC
Model	From 208 to 480 V L-L ac, 5(6) A, connection via TA	System: <ul style="list-style-type: none"> <li>• three-phase (4-wire)</li> <li>• two-phase (3-wire)</li> <li>• single-phase (2-wire)</li> </ul>	Auxiliary power supply from 100 to 277 V ac/dc	Pre-installed MABC module for communications with TCD12s

### Compatible accessory modules part numbers (rear of module)

Part number	Type	Module description
M F I6 O6	Digital inputs/outputs	Six digital inputs and six static outputs
M F I6 R4		Six digital inputs and four relay outputs
M A T P N	Analog inputs	A 1 A input for neutral current, a temperature probe input, a 20 mA analog input
M C 485232	Communication	Modbus RTU communication on RS485/RS232
M C ETH		Modbus TCP/IP communication on Ethernet

## Features

### TCD12 part number

TCD12	BS	32A	x
Model	Split core sensor	Rated current 32 A	No option included

### TCD12WS cable part number

TCD12WSS2TI	XXX
Model	Length: 030: 30 cm 050: 50 cm 100: 100 cm 200: 200 cm 300: 300 cm 500: 500 cm





**CARLO GAVAZZI Controls SpA**

---

via Safforze, 8  
32100 Belluno (BL) Italy

[www.gavazziautomation.com](http://www.gavazziautomation.com)  
[info@gavazzi-automation.com](mailto:info@gavazzi-automation.com)  
info: +39 0437 355811  
fax: +39 0437 355880

