



CARLO GAVAZZI

Loop Detector Single Loop Plug In

LDP1PA2DU24-4

Instruction manual

Table of contents

1. Introduction	3
1.1 Description	3
1.2 Validity of documentation	3
1.3 Who should use this documentation	3
1.4 Use of the product	3
1.5 Safety precautions	3
1.6 Other documents	3
2. Product	4
2.1 Main features	4
2.2 Identification number	4
2.3 Specifications	5
3. Wiring diagrams	6
4. Structure	6
5. LED indications	7
5.1 Power / fault indicator LED	8
5.2 Loop state LED	8
5.3 Relay state LED	8
6. Dip Switch	9
DIP Switch settings	9
7. Loop installation	13
7.1 Dimension and placement of the loop	13
7.2 Inductance and loop turns	14
7.3 Loop wire material	15
7.4 Feeder cable	17
7.5 Ground Installation	17
8. Product Setup Guide	17
8.1 Channel Selection	17
8.2 Sensitivity adjustment	18
8.3 Automatic Sensitivity Boost (ASB)	19
8.4 Fail Safe and Fail Secure mode	20

1. Introduction

This manual is a reference guide for LDP1PA2DU24-4. It describes the product specifications as well as how to install, set up and use the product for its intended use.

1.1 Description

LDP1PA2DU24-4 is a device designed and manufactured in accordance with IEC international standards and are subject to the Low Voltage (2014/35/EU) and Electromagnetic Compatibility (2014/30/EU) EC directives.

All rights to this document are reserved by Carlo Gavazzi Industri: copies may be made for internal use only. Please do not hesitate informing us to make any suggestions for improving this document.

1.2 Validity of documentation

This manual is valid only for LDP1PA2DU24-4 Loop Detector and until any newer documentation is published. This instruction manual describes the functions, operations and installation of the product for its intended use.

1.3 Who should use this documentation

This manual contains important information regarding installation and must be read and completely understood by specialized personnel dealing with these kinds of devices.

We highly recommend that you read the manual carefully before installing the Loop Detector. Please save the manual for future use. The installation manual is intended solely for qualified technical personnel.

1.4 Use of the product

The Loop Detector is primarily used to detect vehicles such as cars, trucks, buses and others.

A loop in the ground is required for the Loop Detector to detect any vehicles above the loop. The device works on the same principle of an inductive sensor; utilizing the phenomenon of eddy current. When a metal target/vehicle approaches on top of the loop, the magnetic field generated by the loop interacts with the target and makes the Loop Detector to change its output.

The Loop Detector can be used at carpark barriers, bollards, gates, toll gantries and many other door access applications.

1.5 Safety precautions

This Loop Detector must not be used in applications where personal safety depends on the function of the Loop Detector.

Installation and use must be carried out by trained technical personnel with basic electrical installation knowledge. The installer is responsible for correct installation according to local safety regulations and must ensure that a defective Loop Detector will not result in any hazard to people or equipment. If the Loop Detector is defective, it must be replaced and secured against unauthorized use.

1.6 Other documents

It is possible to find the datasheet, manuals, brochures and electrical drawings on the Internet at <http://gavazziautomation.com>

2. Product

2.1 Main features

- Loop input inductance: 20 μ H to 1000 μ H
- Adjustable sensitivity in 10 steps: 0.01% to 1.00% via potentiometer
- Automatic loop frequency tuning or manual tuning via 4 adjustable loop frequency channels to avoid crosstalk
- Automatic Sensitivity Boost (ASB) for high bed vehicle detection
- Selectable fail safe and fail secure mode
- 2 x SPDT relay outputs, selectable operation as pulse or presence switching
- Multicolor power/fault LED indication for easy setup and intuitive diagnostic
- Individual loop state multicolor LED to indicate different loop status and fault
- Loop diagnostic capability: loop short circuit, loop open circuit, inductance out of range, channel crosstalk
- Wide range power supply: 24-240 VAC/VDC, 45-65 Hz

2.2 Identification number

Code	Option	Description
L	-	Loop
D	-	Detector
P	-	Plug in
1	-	Single loop
P	-	Potentiometer
A	-	Adjustment
2	-	Number of outputs
D	-	2 x SPDT outputs
U24	-	Power supply 24 - 240 VAC/VDC
-4	-	Special number

2.3 Specifications

Loop input inductance	20 μ H ... 1000 μ H
Adjustable sensitivity	0,01% ... 1,00%
Number of adjustable steps	10
Number of frequency channels	4
Frequency range	10 ... 130 kHz
Loop fault detection	Short circuit, open circuit, inductance out of range, frequency crosstalk
Response time	130 ms
Output type	Relay
Number of output	2 x SPDT
Output mode	Pulse or presence; selectable via dip switch
Output Assignment	2 x SPDT for loop 1
Rated operational voltage (output)	250 VAC/VDC
Rated operational current (I_e)	AC1: 5 A @ 250 VAC DC1: 1 A @ 30 VDC
Mechanical lifetime	15×10^6
Electrical lifetime	>100 000 operations (@5A load)
Protection	Reverse polarity and overvoltage
Rated operational voltage (U_B)	24 ... 240 VAC/VDC
Power consumption	24 VAC/VDC < 2 W / 2.5 VA 115 VAC/VDC < 2 W / 3 VA 240 VAC/VDC < 2 W / 4 VA
Rated supply frequency	45 to 65 Hz
Rated insulation voltage	800 V
Rated impulse withstand voltage	4 kV (1.2/50 μ s)
Power-ON delay (t_v)	5 s for manual frequency tuning 10 s for automatic frequency tuning
Ambient temperature	-40° ... +70°C (-40° ... +158°F) (operating) -40° ... +70°C (-40° ... +158°F) (storage)
Ambient humidity range	0% ... 90% (operating) 0% ... 90% (storage)
Overvoltage category	III (IEC)
Degree of protection	IP30 (IEC)
Pollution degree	2 (IEC)
Connection type	11 pin circular plug-in
Connection at socket (ZPD11A)	Screw terminal
Housing material	PPO PX9406-802, PPO Noryl SE1
Colour	RAL 7035 (Grey)
Dimensions	81 mm (h) x 35.5mm (w) x 60.2mm (d)
Weight	105 g

3. Wiring diagrams

LDP1PA2DU24-4 required to be plugged into a socket ZPD1 1A or equivalent which is sold separately.

LDP1PA2DU24-4 plug configuration

1	Earth
2	Supply
3	Relay 1 Normally Closed (NC)
4	Relay 1 Normally Open (NO)
5	Relay 2 Normally Closed (NC)
6	Relay 2 Common (COM)
7	Loop
8	Loop
9	Supply
10	Relay 1 Common (COM)
11	Relay 2 Normally Open (NO)

Earth pin must be connected to earth
Do not wipe grease off pins

4. Structure

LDP1PA2DU24-4

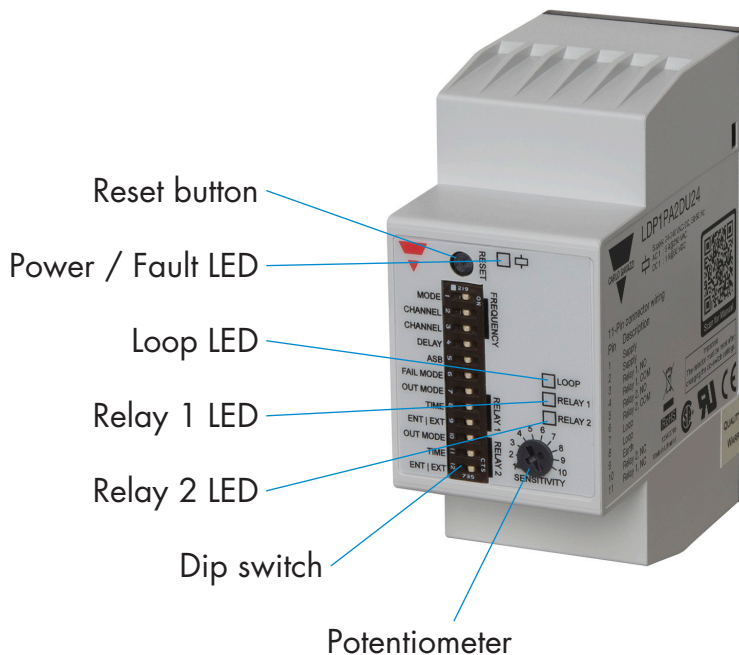



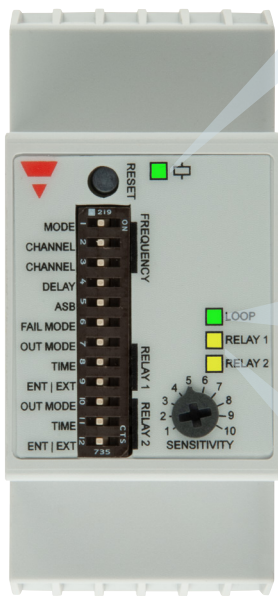

5. LED indications



LDP1PA2DU24-4 have 3 categories of LED indications; Power/Fault indicator LED, Loop state LED and Relay state LED:



Power / fault indicator

LED colour	LED constant	LED Flashing
	All OK (ASB OFF)	DIP switch changed, but changes not in effect
	All OK (ASB ON)	-
	Low signal indication	-
	Channel crosstalk	-
	-	Indication of the frequency channel





Loop state LED

LED colour	LED constant	LED Flashing
	Inductance OK	-
	Inductance too high	Inductance too low
	Loop is open circuit	Loop is short circuit

Relay state LED

LED colour	Mode	Relay deactivated	Relay activated
	Presence mode	LED OFF	LED ON
	Pulse mode, 0.1 s	LED OFF	LED ON for 0.5 s
	Pulse mode, 0.5 s	LED OFF	LED ON for 1.0 s



5.1 Power / fault indicator LED

LED colour	LED constant	LED Flashing
	All OK (ASB OFF)	DIP switch changed, but changes not in effect
	All OK (ASB ON)	-
	Low signal indication	-
	Channel crosstalk	-
	-	Indication of the frequency channel

Explanation:

- Green LED (steady): Unit is powered up and everything is working well
- Green LED (flashing): Dip switch has been changed since power up, but change has not taken effect. Please press the reset button
- Blue LED (steady): Automatic Sensitivity Boost is turned ON and everything is working well
- Yellow LED (steady): Signal level is low in the loop. It is recommended to increase sensitivity
- Red LED (steady): Crosstalk of loop frequency with another loop detected. Select different frequency channel on DIP switches and reset product
- White LED (flashing): After start up, the number of times the LED flashes, indicates the frequency channel selected in both manual and automatic frequency tuning mode (e.g. LED flashes two times is equivalent to channel 2)

5.2 Loop state LED

LED colour	LED constant	LED Flashing
	Inductance OK	-
	Inductance too high	Inductance too low
	Loop is open circuit	Loop is short circuit

Explanation:

- Green LED (steady): Loop inductance is within limit and working well
- Yellow LED (steady): Loop inductance is too high (more than 1000 μ H)
- Yellow LED (flashing): Loop inductance is too low (less than 20 μ H)
- Red LED (steady): Loop is open circuit
- Red LED (flashing): Loop is short circuit

5.3 Relay state LED

LED colour	Mode	Relay deactivated	Relay activated
	Presence mode	LED OFF	LED ON
	Pulse mode, 0.1 s	LED OFF	LED ON for 0.5 s
	Pulse mode, 0.5 s	LED OFF	LED ON for 1.0 s

Explanation:

- Yellow LED (off): Relay is not activated
- Yellow LED (steady): Relay is activated and in presence mode
- Yellow LED (on for 0.5 s): Relay is activated and in pulse mode, 0.1 s
- Yellow LED (on for 1.0 s): Relay is activated and in pulse mode, 0.5 s

6. Dip Switch

DIP Switch settings

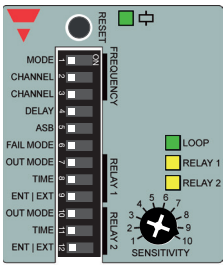

Frequency settings						
1	Selection mode	Automatic channel selection <input type="checkbox"/>		Manual channel selection <input type="checkbox"/>		
2	Channel selection	DIP switch 2 and 3 are not used in automatic channel selection		1	2	3
3				<input type="checkbox"/> <input type="checkbox"/>	<input type="checkbox"/> <input type="checkbox"/>	<input type="checkbox"/> <input type="checkbox"/>
General settings						
4	Turn-on delay	Delay OFF <input type="checkbox"/>		Delay 2.0 sec <input type="checkbox"/>		
5	ASB	ASB OFF <input type="checkbox"/>		ASB ON <input type="checkbox"/>		
6	Failure mode	Fail safe <input type="checkbox"/>		Fail secure <input type="checkbox"/>		
Relay 1 settings						
7	Output mode	Pulse mode <input type="checkbox"/>		Presence mode <input type="checkbox"/>		
8	Time	0.1 sec pulse <input type="checkbox"/>	0.5 sec pulse <input type="checkbox"/>	Infinite <input type="checkbox"/>	60 min <input type="checkbox"/>	10 min <input type="checkbox"/>
9		Entry / Exit	Vehicle entry <input type="checkbox"/>	Vehicle exit <input type="checkbox"/>	<input type="checkbox"/>	<input type="checkbox"/>
10	Output mode	Pulse mode <input type="checkbox"/>		Presence mode <input type="checkbox"/>		
11	Time	0.1 sec pulse <input type="checkbox"/>	0.5 sec pulse <input type="checkbox"/>	Infinite <input type="checkbox"/>	60 min <input type="checkbox"/>	10 min <input type="checkbox"/>
12		Entry / Exit	Vehicle entry <input type="checkbox"/>	Vehicle exit <input type="checkbox"/>	<input type="checkbox"/>	<input type="checkbox"/>

DIP SWITCH 1 - Frequency mode selection

The Loop Detector operates on one out of four channels. If the Loop Detector is located near sources of electrical or magnetic disturbances, e.g. from other Loop Detectors, some channels can be more advantageous to use than others. Two Loop Detectors placed in close proximity of each other should use different channels to avoid crosstalk between the loops.









- When DIP SWITCH 1 is set to **ON**, the user manually selects which channel is used by setting DIP switch 2 and 3.

- When DIP SWITCH 1 is set to **OFF**, during startup the Loop Detector automatically measures disturbances present on all four channels and selects the channel with best signal conditions. Note that this procedure will be performed every time the Loop Detector is powered up or reset.

The white LED will show which channel has been selected (refer to the Indication Session on page 8)

DIP SWITCH 2 and 3 - Frequency channel selection

These two DIP switches are used to select which channel the Loop Detector should use. The channels can only be selected when manual channel selection is set on DIP switch 1. When mode is set to automatic channel selection, DIP switch 2 and 3 do not have any function.

DIP switch	Frequency Channel 1	Frequency Channel 2	Frequency Channel 3	Frequency Channel 4
2	OFF 	ON 	OFF 	ON 
3	OFF 	OFF 	ON 	ON 

DIP SWITCH 4 - Turn-on delay

The Loop Detector has a Turn-on delay filter which can be enabled to help to avoid false vehicle detections.

- When DIP SWITCH 4 is set to **ON**, the Turn-on delay is activated and any detections shorter than 2 seconds will not cause the output to activate. This function is suitable for detection of stationary or slow moving vehicles.
- When DIP SWITCH 4 is set to **OFF**, the Turn-on delay is disabled and output has normal response time. This function is suitable for detection of fast moving vehicles.

DIP SWITCH 5 - Automatically Sensitivity Boost (ASB)

High bed vehicles such as trucks and trailers normally gives a strong signal when the wheel axles are inside the circumference of the loop. However the signal drops significantly when the loop is between the wheel axles or between a truck and its trailer. When ASB function is enabled, the sensitivity is boosted to avoid output deactivation when signal level is reduced, but high bed vehicle is still on top of the loop.

- When DIP SWITCH 5 is set to **ON**, the ASB function is active and sensitivity is boosted to avoid false deactivations. This mode is recommended for applications where detection of trucks and other high bed vehicles is needed.
- When DIP SWITCH 5 is set to **OFF**, the Loop Detector uses normal sensitivity levels. This mode is recommended for detection of normal cars, vans etc. with low bed height.

DIP SWITCH 6 - Failure mode

This function determines the state of the output relays, both during normal operation and when a failure is detected in the system.

⚠ Note: When Fail Safe mode is selected, the operation of both output relays will be inverted. This means that the Normally Open (NO) contact will become a Normally Closed (NC) contact and the Normally Closed (NC) contact will become a Normally Open (NO) contact.

- When DIP SWITCH 6 is set to **ON**, the product will operate in FAIL SECURE mode. In case of a failure on the Loop Detector, in the loop wire or loss of power, the outputs will indicate no detection of a vehicle.
- When DIP SWITCH 6 is set to **OFF**, the product will operate in FAIL SAFE mode. In case of a failure on the Loop Detector, in the loop wire or loss of power, the outputs will indicate detection of a vehicle.

DIP SWITCH 7 - Output mode for relay 1

This setting determines how relay 1 should indicate a vehicle detection in the loop. The Loop Detector can generate a single pulse, each time a vehicle enters or leaves the loop (Pulse mode). Alternatively the output can be kept activate as long as there is a vehicle present inside the loop (Presence mode).

- When DIP SWITCH 7 is set to **ON** relay 1 operates in Presence mode and output is activated as long as a vehicle is present inside the loop.
- When DIP SWITCH 7 is set to **OFF** relay 1 operates in Pulse mode and generates a pulse each time a vehicle enters or leaves the loop.

⚠ Note: DIP switch 8 and 9 will have different functionality depending if product is set to operate in Pulse or Presence mode on DIP switch 7.

DIP SWITCH 8 - Time setting for relay 1 (only for Pulse mode)

When the Loop Detector is operating in Pulse mode (see DIP switch 7), the pulse length can be changed with DIP switch 8.

- When DIP SWITCH 8 is set to **ON** relay 1 creates a pulse with a duration of 0.5 s for each activation.
- When DIP SWITCH 8 is set to **OFF** relay 1 creates a pulse with a duration of 0.1 s for each activation.









DIP SWITCH 9 - Entry or Exit mode for relay 1 (only for Pulse mode)

When the Loop Detector is operating in Pulse mode (see DIP switch 7), the output pulse can be generated either when a vehicle enters the loop or when a vehicle exits the loop. This is selected by DIP switch 9.

- When DIP SWITCH 9 is set to **ON** relay 1 creates a pulse each time a vehicle exits the loop.
- When DIP SWITCH 9 is set to **OFF** relay 1 creates a pulse each time a vehicle enters the loop.

DIP SWITCH 8 & 9 - Timeout setting for relay 1 (only for Presence mode)

When relay 1 is operated in Presence mode (see DIP switch 7), a timeout can be set to limit maximum activation time of a single vehicle detection. If timeout is set different from infinite, the output will automatically deactivate, if a vehicle has been constantly detected for longer time than set by DIP switch 8 and 9.

DIP switch	Infinite	1 hour	10 minutes	1 minute
8	OFF 	ON 	OFF 	ON 
9	OFF 	OFF 	ON 	ON 

DIP SWITCH 10 - Output mode for relay 2

This setting determines how relay 2 should indicate a vehicle detection in the loop. The Loop Detector can generate a single pulse each time a vehicle enters or leaves the loop (Pulse mode). Alternatively the output can be kept activate as long as there is a vehicle present inside the loop (Presence mode).

- When DIP SWITCH 10 is set to **ON** relay 2 operates in Presence mode and output is activate as long as a vehicle is present inside the loop.
- When DIP SWITCH 10 is set to **OFF** relay 2 operates in Pulse mode and generates a pulse each time a vehicle enters or leaves the loop.

▲ Note: DIP switch 11 and 12 will have different functionality depending if product is set to operate in Pulse or Presence mode on DIP switch 10.

DIP SWITCH 11 - Time setting for relay 2 (only for Pulse mode)

When the Loop Detector is operated in Pulse mode (see DIP switch 10), the pulse length can be changed with DIP switch 11.

- When DIP SWITCH 11 is set to **ON** relay 2 creates a pulse with a duration of 0.5 s for each activation.
- When DIP SWITCH 11 is set to **OFF** relay 2 creates a pulse with a duration of 0.1 s for each activation.

DIP SWITCH 12 - Entry or Exit mode for relay 2 (only for Pulse mode)

When the Loop Detector is operated in Pulse mode (see DIP switch 10), the output pulse can be generated either when a vehicle enters the loop or when a vehicle exits the loop. This is selected with DIP switch 12.

- When DIP SWITCH 12 is set to **ON** relay 2 creates a pulse each time a vehicle exits the loop.
- When DIP SWITCH 12 is set to **OFF** relay 2 creates a pulse each time a vehicle enters the loop.

DIP SWITCH 11 & 12 - Timeout setting for relay 2 (only for Presence mode)

When relay 2 is operated in Presence mode (see DIP switch 10), a timeout can be set to limit maximum activation time of a single vehicle detection. If timeout is set different from infinite, the output will automatically deactivate, if a vehicle has been constantly detected for longer time than set by DIP switch 11 and 12.

DIP switch	Infinite	1 hour	10 minutes	1 minute
11	OFF <input type="checkbox"/>	ON <input checked="" type="checkbox"/>	OFF <input type="checkbox"/>	ON <input checked="" type="checkbox"/>
12	OFF <input checked="" type="checkbox"/>	OFF <input type="checkbox"/>	ON <input checked="" type="checkbox"/>	ON <input checked="" type="checkbox"/>

7. Loop installation

A proper installation of the loop in the road, is the single most important factor for achieving a reliable detector system. Most detection issues are caused by improper loop installation. Please read the guidelines below carefully to ensure best possible performance in the application.

7.1. Dimension and placement of the loop

The first thing to consider when installing a new loop is the dimension and placement. The dimension of the loop is dependent on the road size and is normally rectangular in shape with chamfered corners. The loop should be placed with approximately 30 cm (1 foot) distance to the edge of the road and other road lanes. This helps to prevent false detections caused by traffic passing in adjacent traffic lanes.

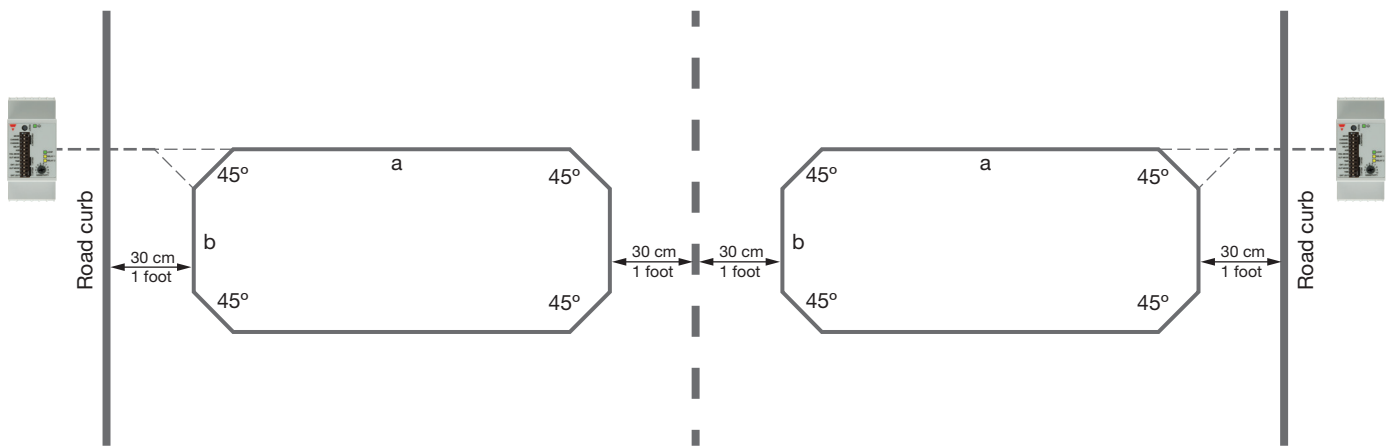

To reduce stress on the cable and thereby prolong its service life, it is important to avoid sharp bending of the cable. This is done by cutting a groove at 45 degree angles in each corner. The best signal condition for detecting a vehicle, is obtained when the width of the loop (a) is approximately the same as the track width of the vehicle. The width of the loop should therefore aim to have same dimension as the vehicles which needs to be detected.

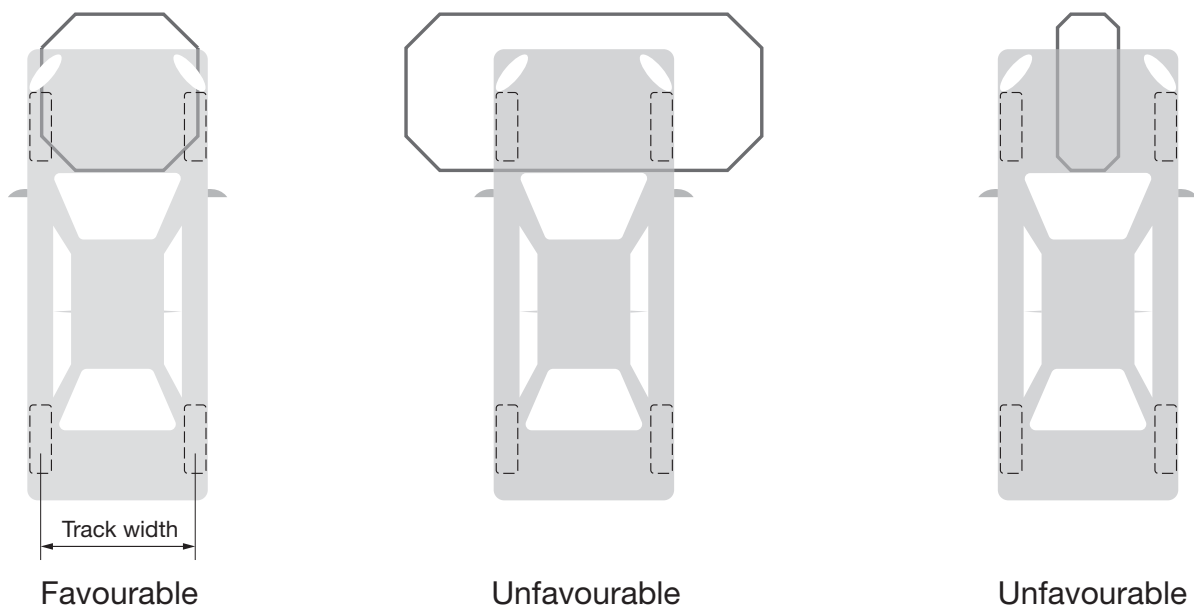

When the Loop Detector powers up or is reset, it automatically tunes to its surrounding environment. This means that stationary metal objects such as poles, cabinets and grates do not affect the Loop Detector. It is however important to ensure a safe distance between the loops and such moving metal objects, e.g., gates. In applications where there are moving metal objects, it is important to ensure minimum distance of 1 meter (3.3 feet) between the loop and the object. Otherwise this can affect the loop and cause false detections.

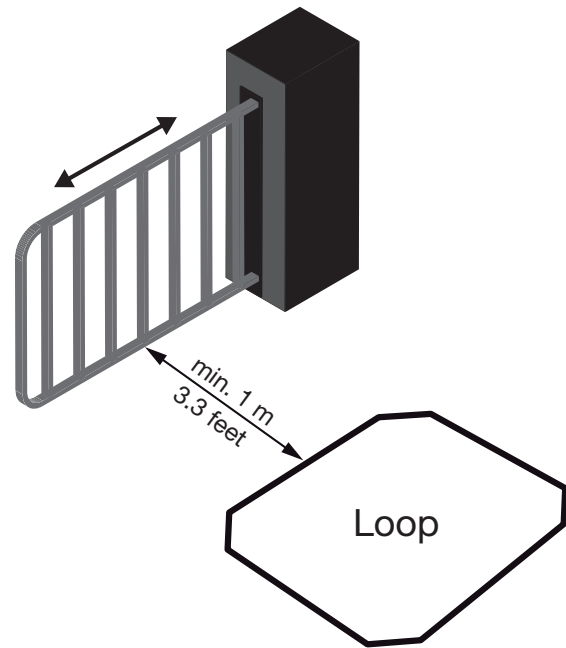

The length of the loop (b) influences the maximum speed at which a vehicle can be traveling and still be detected. For applications where detection of high speed vehicles is needed, it is important to consider this length. The table below shows relation between loop length (b) and maximum vehicle speed. The table below assumes correct adjustment of the Loop Detector sensitivity and a minimum vehicle length of 2.5 meters.

Minimum Loop Length (b)	Maximum vehicle speed	Minimum Loop Length (b)	Maximum vehicle speed
0.25 meter	75 km/h	0.8 feet	47 mph
0.50 meter	80 km/h	1.6 feet	50 mph
1.00 meter	95 km/h	3.3 feet	59 mph
2.00 meter	120 km/h	6.6 feet	75 mph
5.00 meter	200 km/h	16.4 feet	124 mph

7.2. Inductance and loop turns

To ensure the best operation condition, the inductance of the loop should be between 80 μH and 300 μH . This is achieved by matching the recommended number of turns in the loop, with the circumference of the loop according to the table below.

Loop circumference ¹⁾	Recommended turns (80 μH)	Minimum turns (20 μH)
2 meter (6.6 feet)	13	9
5 meter (16.4 feet)	7	5
6 - 7 meter (19.7 - 23 feet)	6	4
8 - 9 meter (26.2 - 29.5 feet)	5	3
10 - 14 meter (32.8 - 45.9 feet)	4	3
15 - 23 meter (49.2 - 75.5 feet)	3	2
24 - 30 meter (78.7 - 98.4 feet)	2	1

¹⁾ Loop circumference = 2 x a + 2 x b.

When installing multiple turns in the loop, it is recommended to place the wires like shown in figure below.

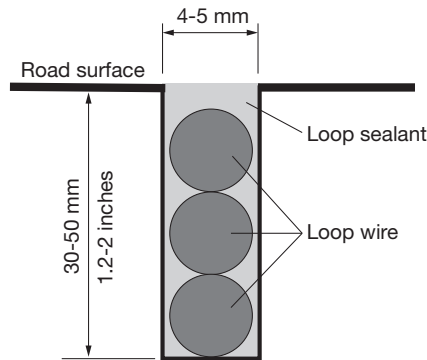

The recommended groove depth is 30-50 mm (1.2-2.0 inches). If the wires are installed deeper than 50 mm (2.0 inches), the detection signal for the Loop Detector is reduced and detection of high bed vehicles can be compromised.

⚠ Note: A common problem for loop failures is wire splicing. It is recommended to use one continuous wire without any splices. If wire splicing is used, the wires must be soldered. Screw or spring terminals are not allowed. All wire splices must be insulated against moisture with adhesive-lined heat shrink tubing or equivalent.

7.3. Loop wire material

It is important to select the right type of cable for the loop wire. If insulating material is not suitable for the application, the cable jacket can crack or absorb moisture. It is a common problem to have moisture penetration in the cable jacket, which can cause a wire shorting to ground. This can lead to conditions where the application works well while it is dry, but starts failing in high humidity conditions or rain. A cracked cable insulation can lead to similar issues.

Cable recommendations:

- Wire insulating material of Cross Linked Polyethylene (XLPE) is recommended for both cold and hot sealant.
- Wire insulating material of PVC (TFFN, THHN, THWN) is only recommended for hot sealant and if the wires are encapsulating completely. Otherwise PVC insulating material is not advised.
- It is important to avoid any voids in the sealing around the cable. This can allow moisture to build up and cause loop failures.

To troubleshoot broken wires an insulation tester (500 MΩ minimum) can be used. Place one wire from the meter to the disconnected wire loop and place the other meter wire in the ground. Testing should be performed with AC voltage.

Measured resistance	Conclusion
100 to 1000 MΩ	Loop condition is good
50 to 100 MΩ	Loop integrity is questionable
0 to 50 MΩ	Loop needs to be replaced

7.4. Feeder cable

It is important to pay attention to the installation of the feeder cable between the Loop Detector and the loop. The groove between the corner of the loop, to the edge of the road, should follow same recommendations as for loop installation.

▲ Note: The feeder cable must be twisted at least 20 turns per meter all the way from the corner of the loop, to the Loop Detector and be fixated right up to the Loop Detector terminals.

The maximum recommended length of the feeder cable is dependent on the wire gauge. For long wire lengths, the cross section of the cable should be bigger.

Cable gauge [mm ²]	Cable gauge [AWG]	Maximum recommended length
0.75 mm ²	18 AWG	20 meter (66 feet)
1.50 mm ²	15 AWG	40 meter (131 feet)
2.50 mm ²	13 AWG	50 meter (164 feet)

The following rules must be followed to ensure reliable detection:

- The feeder cable should not run in parallel with other electrical wires. A minimum distance of 10 cm between feeder wire and other cables is required.
- Excess feeder wire should be cut off to suitable length. It must never be coiled up or stuffed inside the control cabinet.
- The feeder cable must be fixated all the way from the corner of the loop to the Loop Detector. Movement of the feeder cable during operation can lead to false detections.
- Feeder wires from adjacent Loop Detectors, should not be placed in close proximity of each other.

7.5 Ground Installation

The loop wire can be installed in most road surfaces, but it is important to ensure a stable foundation. Installation in asphalt or concrete are the most common and will give the most stable performance. It is important that the loop wire does not move when the surface layer is under stress from vehicles. If this happens the Loop Detector can create false detections. A stable wire installation is especially critical when the Loop Detector is operating at high sensitivity settings or with ASB enabled. Wire movement can for example be created by following the conditions:

- If the surface layer is too thin to support vehicle load
- If the groove is cut all the way through the surface layer
- If the foundation beneath the surface layer is not stable e.g. soil, sand or uncompressed gravel

The loop can be installed together with rebar (reinforced concrete) as long as the loop is placed on top of the iron bars. If electrical heating of the road surface is needed, it is recommended to use 2-wire cable types.

8. Product Setup Guide

The following section gives a general introduction of how to adjust the Loop Detector. Note that changes performed on the DIP switches will not take effect until the product has been restarted. The sensitivity dials can be adjusted while the product is running and will take effect immediately without restart.

⚠ WARNING: Before making any changes to the product settings, make sure no persons or vehicles can be hit by any closing/opening mechanisms connected to the output of the Loop Detector.

8.1 Channel Selection

The Loop Detector can operate on four different frequency channels. This allows up to four individual loops to operate in close proximity of each other without mutual influence. If two separate Loop Detectors are operating on the same frequency channel, they may interfere with each other and cause false detections, if the loops are placed too close. Changing the frequency channel on one of the detectors can eliminate this problem.

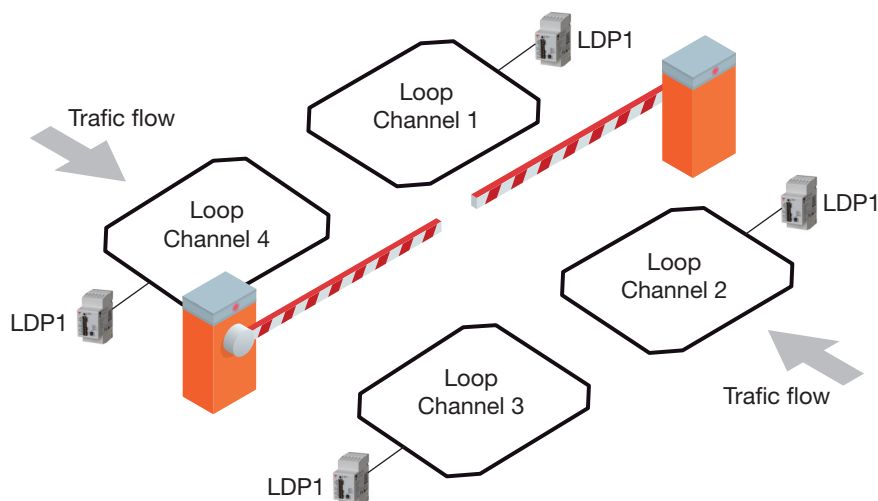

When the Automatic Channel Mode is selected, the Loop Detector scans all four channels during the first 10 seconds after start up. Based on this measurement the Loop Detector selects the channel which is least exposed to disturbance from neighbouring loops and other electrical or magnetic sources of noise. After automatic channel selection is completed, the power LED flashes white to indicate which channel is selected e.g. three flashes shows channel three is selected.

8.2 Sensitivity adjustment

The adjustment of the sensitivity for each loop, is easily performed using the rotary switch on the front. The sensitivity can be changed in 10 steps from 1 to 10, where 1 is the lowest sensitivity and 10 is the highest. It is important to find the right compromise between selecting high enough sensitivity to safely detect all types of vehicles, while keeping it low enough to avoid false detections. If the sensitivity is set too high, the Loop Detector can make false detections e.g. from bicycles, safety shoes with steel toes or vehicles passing next to the loop, not over it.

It is recommended to start sensitivity adjustment from step 5. This sensitivity is normally suitable for detection of passenger cars, vans etc. but depending on loop installation and type of vehicles to be detected, a different setting might be needed.

For applications where detection of high bed vehicles is needed, please also refer to section 8.3 Automatic Sensitivity Boost for a more detailed description.

⚠ CAUTION: It is important to carefully test the application before the system is put into operation. Setting the sensitivity too high or too low, can lead to unexpected behaviour of the application.

8.3 Automatic Sensitivity Boost (ASB)

Trucks, trailers and other high bed vehicles often require use of high sensitivity setting to avoid deactivations when the bed of the vehicle is on top of the loop. For this reason the Loop Detector has a special function called Automatic Sensitivity Boost (ASB). When this function is enabled the deactivation level is lowered. This helps to prevent false deactivations (see figure below).

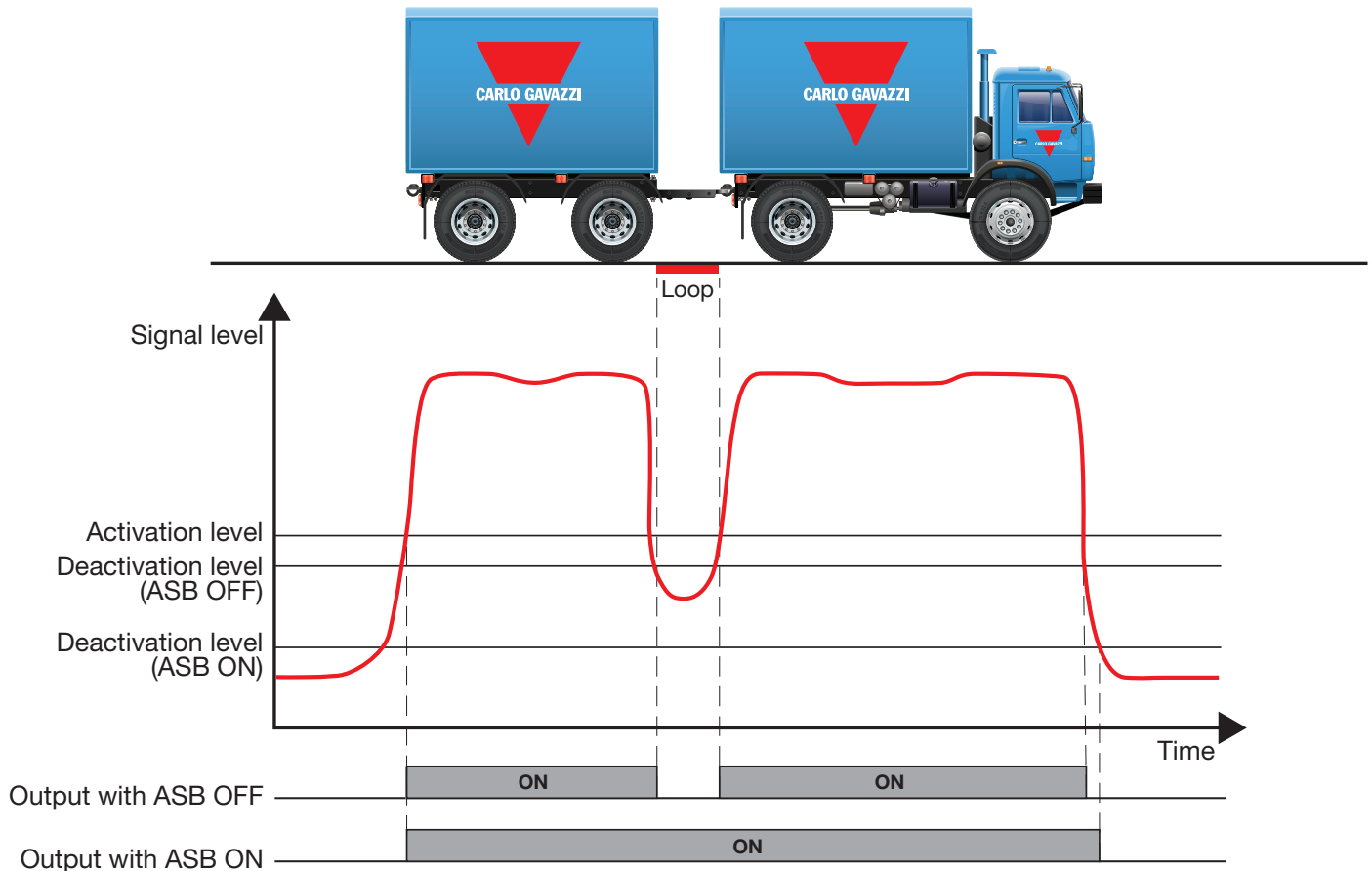

The sensitivity adjustment dial works in the same way with or without ASB function ON, by lowering or increasing the activation threshold. However by utilizing the ASB function it is possible to have correct detection of high bed vehicles for lower sensitivity settings.

⚠ Note: It is generally recommended to only use the ASB function for applications where high bed vehicles need to be detected. For detection of passenger cars, vans etc. best detection is usually achieved with ASB OFF.

8.4 Fail Safe and Fail Secure mode

In case of a broken wire in the loop wire or loss of power to the Loop Detector, the fail Safe/Secure function allows the user to decide which position the output relay should change to.

Failure mode set to secure

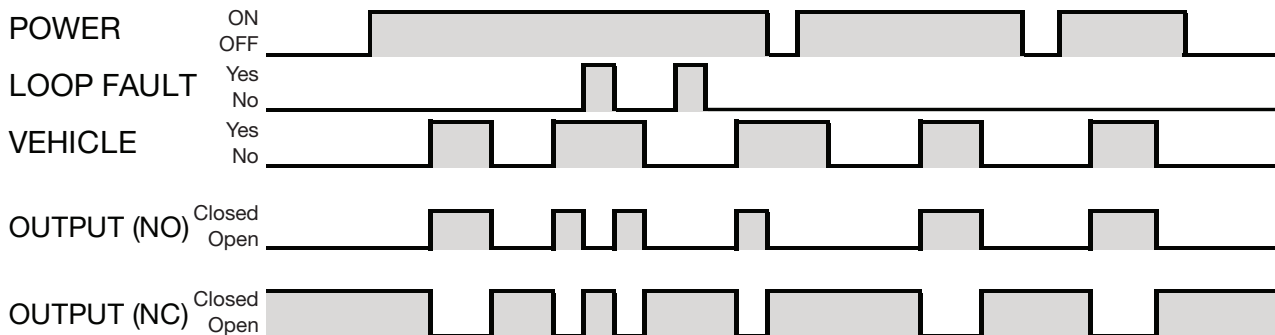

Failure mode set to safe

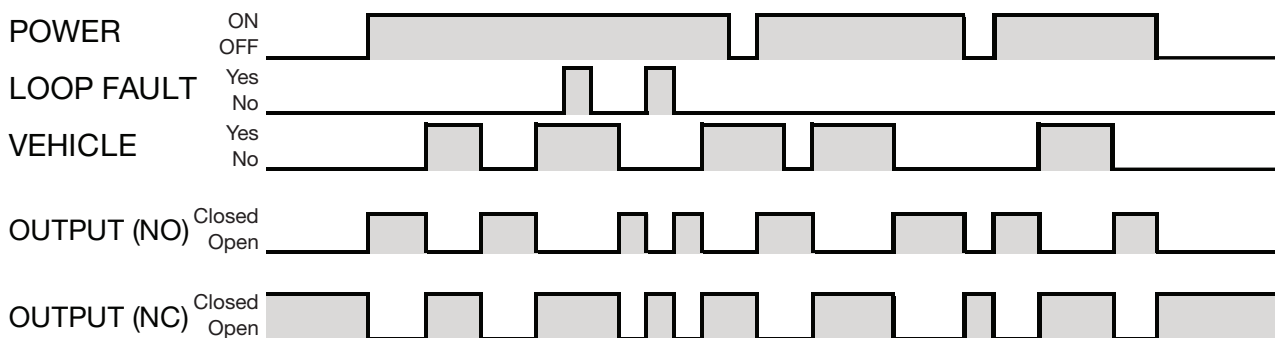

In Fail Secure mode the output relays operate normally while there are no issues in the application. If an error is detected or power to the Loop Detector is lost, the outputs will always fall back to default output state which is no vehicle detection in the loop. This function can be used if it is important to close the gate or barrier in case of problems.

In Fail Safe mode the output relays operate inverted while there are no issues in the application. This means that the Normally Open (NO) relay contact becomes Normally Closed (NC) and the Normally Closed (NC) relay contact becomes Normally Open (NO). If an error is detected or power to the Loop Detector is lost, the outputs will always fall back to default output state which is detection of a vehicle in the loop. This function is used if it is important to open the gate or barrier in case of problems.

⚠ Note: If power is returned to the product while a vehicle car is parked on top of the loop, the Loop Detector will not activate. Only a new vehicle entry will generate an activation.

CARLO GAVAZZI
www.gavazziautomation.com



Certified in accordance with ISO 9001