

ESCO2THW

CO₂, Temperature, Humidity

Transmitter



Instruction Manual

V2.0

Instruction Manual

1. Summary.....	4
2. Security considerations.....	5
3. Housing, Dimension & Installation	7
4. General Hardware Feature	9
5. Signal Connection	10
6. Software	11
7. Installing and Using Software ESCO2 Soft.....	13
7.1 Execute “ESCO2 Soft”	14
7.2 Connect to PC via RS-485.....	15
7.3 Scan RS-485 connection.....	18
7.4 Setting RS-485 communication format.....	23
7.5 CO2 Self Correcting ADC.....	25
7.6 Display Tab	27
8. Protocol.....	28
9. Cautions	29
10. Inspection and Maintenance.....	30

Instruction Manual



Instruction Manual

1. Summary

1.1 Features

1. NDIR sensor for CO₂, CMOS sensor for temperature, humidity
2. CO₂ up to 2000ppm or 5000ppm
3. Temperature up to 50°C
4. Humidity up to 100% RH
5. Remote monitor by RS-485 (Modbus RTU)
6. LCD Display
7. 2 x analog output 0-10V and 4-20mA version
8. Setting via software ESCO2 Soft
9. Graph plotting and logging function via software ESCO2 Soft
10. ESCO2 Soft can be download from the Carlo Gavazzi website <http://www.productsonline.info/>

1.2 Applicable Fields

- Ventilation systems
- HVAC installations
- Monitor CO, CO₂ for houses and buildings.

Instruction Manual

2. Security considerations

2.1. Manual Guide

Before using this product, user must read the details of this instruction manual to ensure using this product with the correct steps. This instruction manual is for reference while using/ setting this product and is required to be conserved properly.



Solemn Statement:

1. This product is not to be used in explosion-proof area.
2. Do not use this product in dangerous situation whereby human health & life may be threatened & affected.

2.2. Illustration, Warning & Attention



Carlo Gavazzi will not be held responsible for any accidents and dangerous occurrences resulted from the usage of this product.

Illustration











	This mark is to give advice & warning for the potential dangers which result from obvious wrong/ improper operation steps. (The left mark means "Watch out for electric shock")
	In order to avoid the dangerous situation, this mark means some special operation/ action is forbidden to implement. (The left mark means "Forbidden to Disassemble")
	In order to avoid the dangerous situation, this mark means specific action/ operation is required to implement. (The left mark means "General Instruction")

Instruction Manual

Warning

	Please implement the wiring operation under power-off status; otherwise it will cause electric shock, or become the root cause of machinery breakdown.
	This product must be operated under rated power supplying value and be operated under the ruled normal operation conditions which described in the instruction manual; otherwise it may cause disasters such as fire accident or be the root cause of machinery breakdown.
	Please install this product under normal ambient pressure. Otherwise it may cause safety problems.

Attention

	In order to be in accordance with all applicable safety standards, the installation & wiring must be performed by qualified installer & professional instruments.
	Please ensure the outlook/ packaging box do not have any damage which result from improper transportation or malfunction which results from lost attachments.
	In order to prevent the product from damages, this product must be used in the proper environment specified in this instruction manual.
	All wiring must comply with the rule of indoor wiring and standard electrical installation rules.
	In order to prevent the interferences from frequency converter etc. and to avoid error signal resulted in this product, please use isolated conducting wire.
	In order to prevent this product from short circuit, please install this product according to the wiring diagram on chapter 5.
	In order to prevent affecting this product's accuracy from external interferences, please do not use two-way wireless devices within 3 meters.
	Do not disassemble this product, otherwise it may cause malfunction.
	During product breakdown, please take safety precaution.
	Please recycle the partial or whole parts while discarding this product.
	While discarding this product, the user must comply with the standard rules for industrial domestic wastes in different country/ location.

Instruction Manual

3. Housing, Dimension & Installation

3.1 Housing & Dimension

ESCO2THW

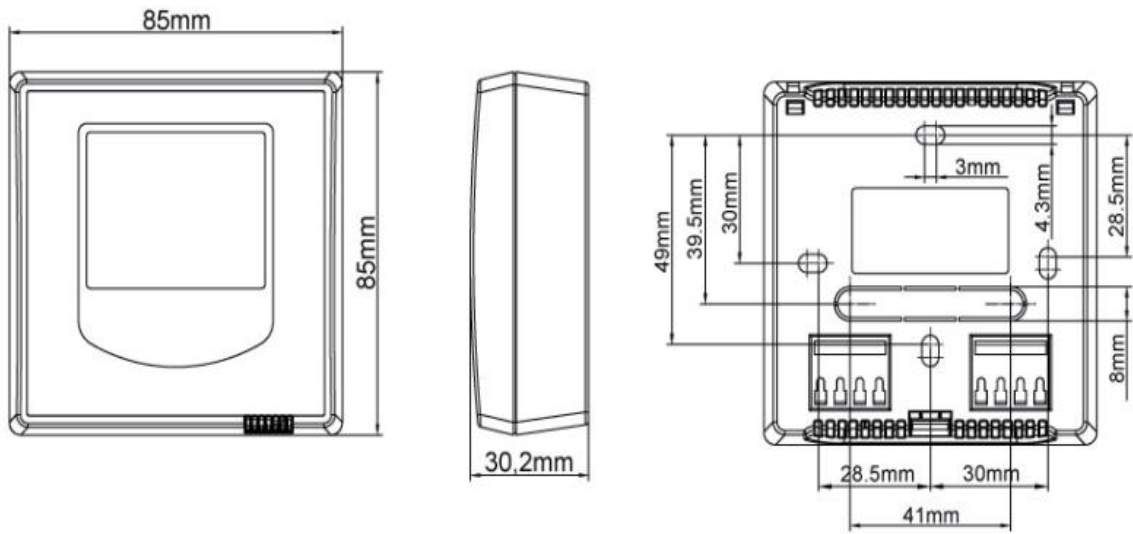

Instruction Manual



ESCO2THW

Instruction Manual

4. General Hardware Specifications

Please refer to the datasheet for detail specifications

ESCO2THW

- Temperature 0 to 50°C
- Humidity 0-100% RH
- CO2 0-2000ppm or 5000ppm
- Power supply 12-36VDC/24VAC
- Accuracy temperature +/-0.5°C, humidity +/-3% RH, CO2 +/-40ppm+3%
- Working temperature 0 to 50°C
- Storage temperature -20 to 60°C
- 2 X output 0-10V or 4-20mA (for temperature, CO2)
- RS485 output as standard (for temperature, CO2, humidity)
- LCD display
- Wall mounting
- Housing PC fire proof class (PC110)
- Electrical connection screw terminals
- Protection degree IP20
- Polarity, short circuit, over voltage protection
- CE marking Yes

Instruction Manual

5. Signal Connection

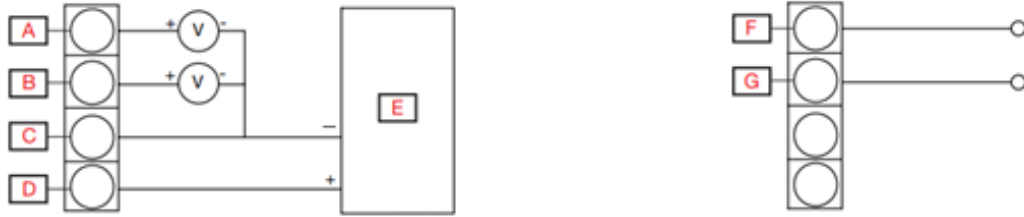

A	CH 1	E	12...36 VDC and 24 VAC
B	CH 2	F	RS485+
C	GND	G	RS485-
D	AC/DC		

Instruction Manual

6. Software

6.1 Minimum System Requirements

Processor:	Intel Pentium 2.4 GHz or faster
OS:	Windows XP, Windows 7, Windows 10
Memory:	512 MB of RAM
Hard Disk:	1 GB free space (for logging)
Display:	XGA (1024x768)
Serial Port:	2-Wire RS-485

For Windows 10 (computer needs to have "Microsoft Dot Net Framework 3.5 SP1" and "Microsoft Chart Controls for Dot Net Framework 3.5 SP1" which normally comes preinstalled with the Windows 10. But if not, please download from the official Microsoft Windows website)

<https://www.microsoft.com/en-sg/download/details.aspx?id=22>
<https://www.microsoft.com/en-sg/download/details.aspx?id=14422>

6.2 RS-485 Serial Communication

This product uses RS-485 Serial Port Interface to connect with the computer, the hardware communication interface is necessary (not included in this product)

1. If the PC equipped with COM Port. Use Converter (RS-232 to RS-485) to connect with this product.
2. In the PC is not equipped with COM Port. Use Converter (USB to RS-485) to connect with this product.

6.3 Self-Correcting Algorithm ADC

1. NDIR is a fast, accurate & precise technology to detect CO₂ concentration. It uses two physical characteristics, to detect the concentration of specified gas,
 - a. The gas absorbs the wavelength of Infrared Rays.
 - b. The gas concentration and absorbed quantity is direct proportion.
2. The strength of Infrared Rays have attenuation phenomenon after long time, affecting the accuracy of measurement. Hence the technology of CO₂ Self-Correcting Algorithm provides improvement for this deflection.
3. In the general environment, the CO₂ concentration usually measured as 400ppm. The environment in unoccupied room/ office during midnight, the CO₂ concentration usually measured as 400ppm. ESCO₂ use the average statistics values for 7 days to implement Self-Correcting feature.
4. This feature is not adaptive to use in special environment as factory/ plant greenroom where the CO₂ concentration may keep on high value & for long period.

Instruction Manual

6.4 Setting Port No. & Transmission Rate

1. RS-485 serial communication interface running with Modbus Protocol
2. Usable Port No. range: 1 to 247.
3. On the same wiring, the Port No. must to be different.
4. The maximum devices which connected to RS-485 interface restricted to 31 devices.
5. Five selectable transmission rate (Baud Rate): 9600 / 19200 / 38400 / 57600 / 115200 bps.

Instruction Manual

7. Installing and Using the Software ESCO2 Soft

7.1 Execute " ESCO2 Soft"	14
7.2 Connect to PC via RS-485	15
7.3 Scan RS-485 connection	18
7.4 Setting RS-485 communication format	23
7.5 CO2 Self Correcting ADC	25
7.6 Display Tab.....	27

Instruction Manual

7.1 Execute “ESCO2 Soft”

1. Free installation file : ESCO2 Soft.exe
 - a. O.S Requirement: Windows XP or above.
 - b. Double click on “ESCO2 Soft.exe” to launch the software

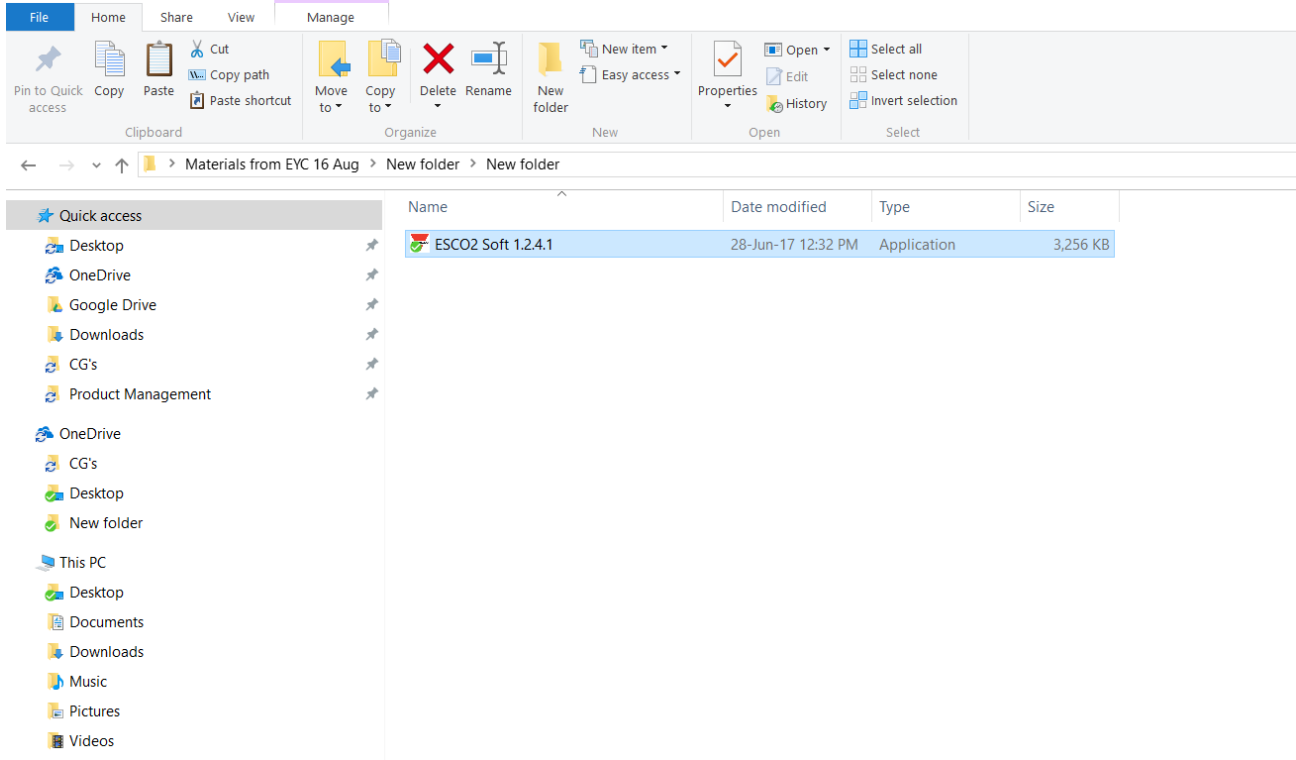

Instruction Manual

7.2 Connect to PC via RS-485

1. Connect this product to PC via RS-485 communication interface devices
2. Click “Interface > Config”

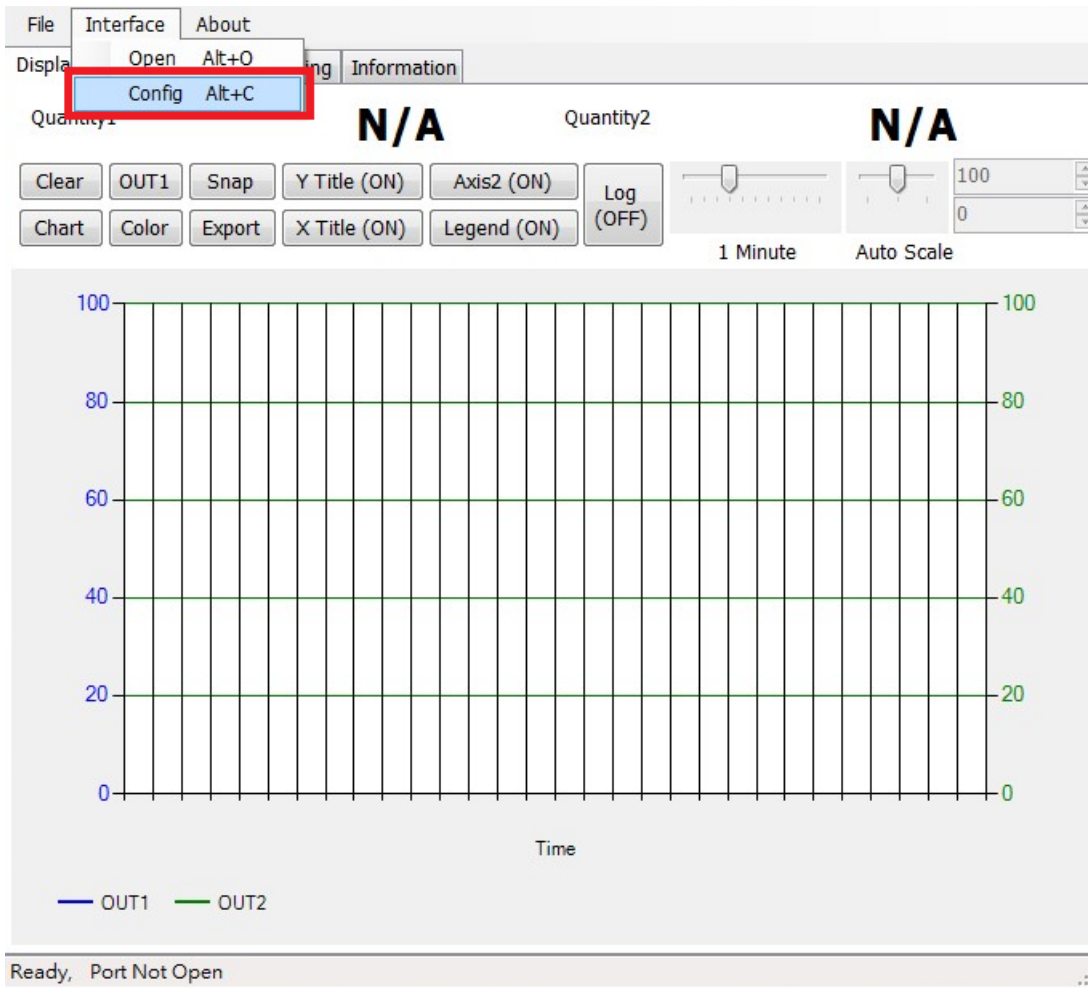

Instruction Manual

3. Select the corresponding values of com port as following:
 - a. Port No of your computer used
 - b. Baud Rate : 9600, 19200, 38400, 57600, 115200
 - c. Data Frame : None-8Bit-1Stop, None-8Bit-2Stop, Even-8Bit-1Stop, Even-8Bit-2Stop, Odd-8Bit-1Stop, Odd-8Bit-2Stop,
 - d. Physical Interface: RS-485
 - e. Station ID (factory default 1)

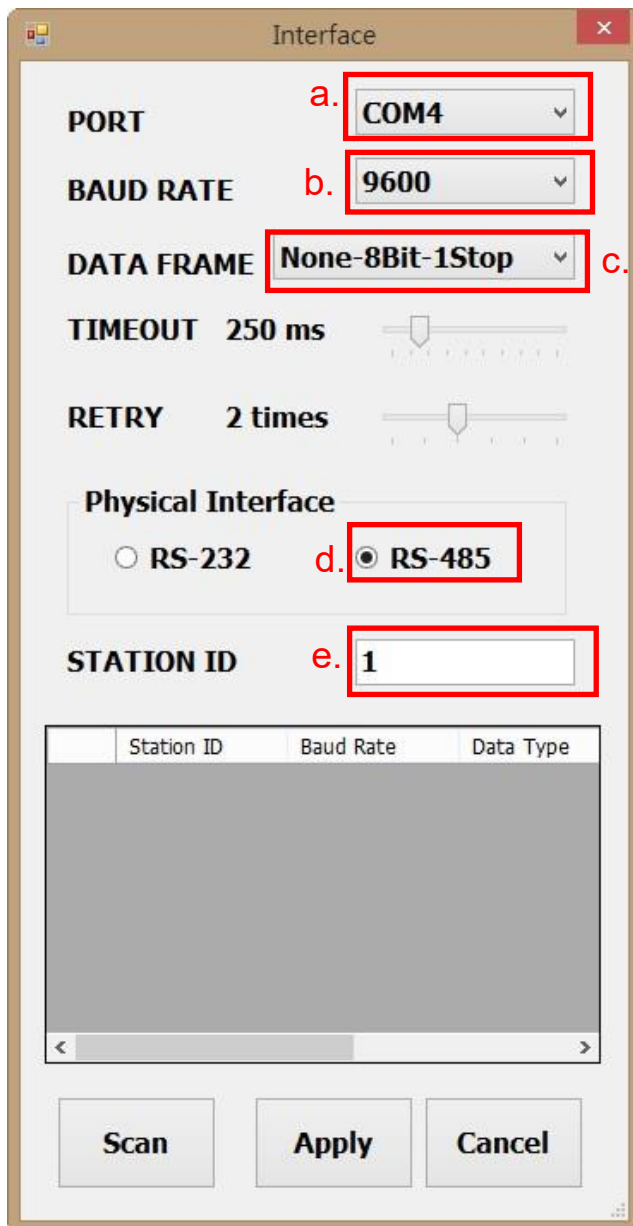

4. Click "Apply" to save the setting
5. Or click "Scan" to scan for devices connected to the same system

Instruction Manual

6. If connection is successful, this window will appear :
 - a. Shows the current measured values
 - b. Shows “Open port, Read successful” in status bar

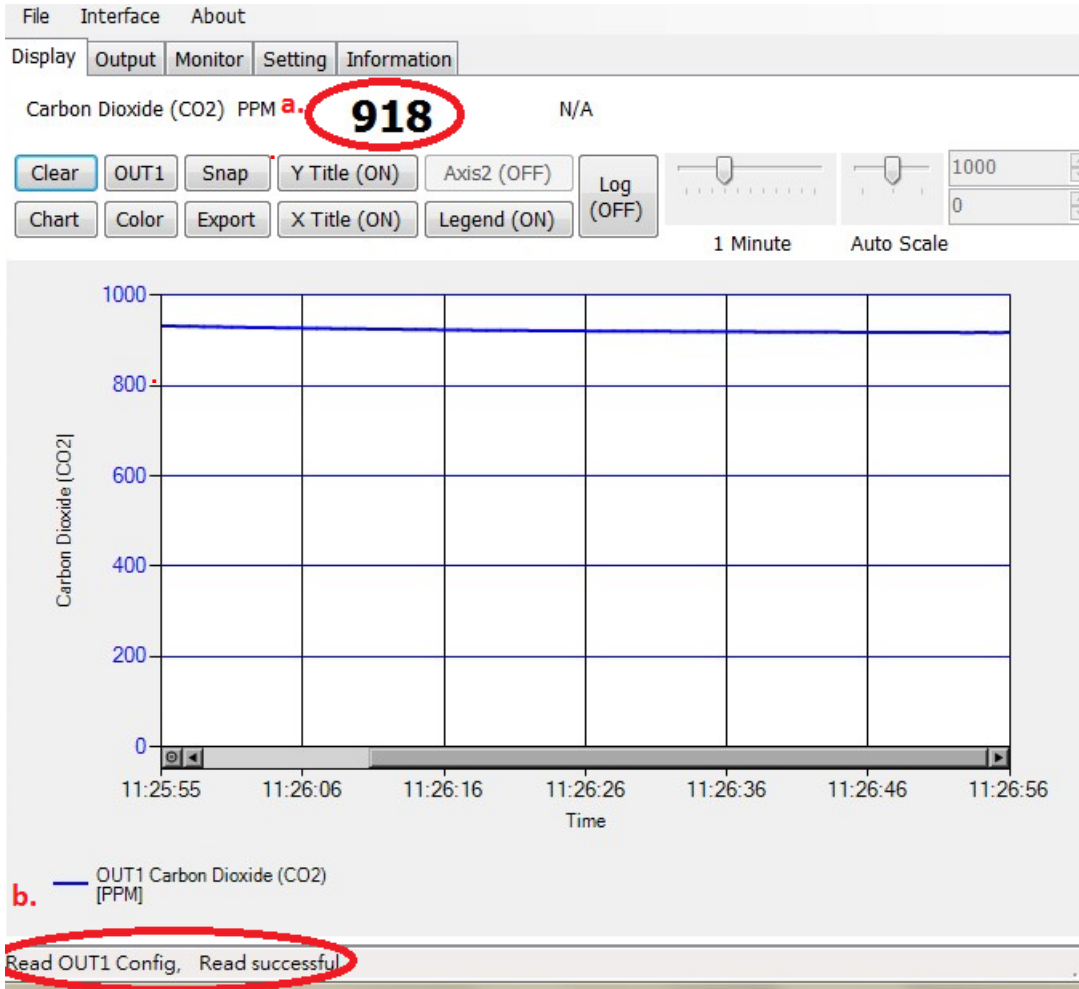

Instruction Manual

7.3 Scan RS-485 connection

1. You can also scan for existing devices that are already connected on the RS485 line by going to the configuration page

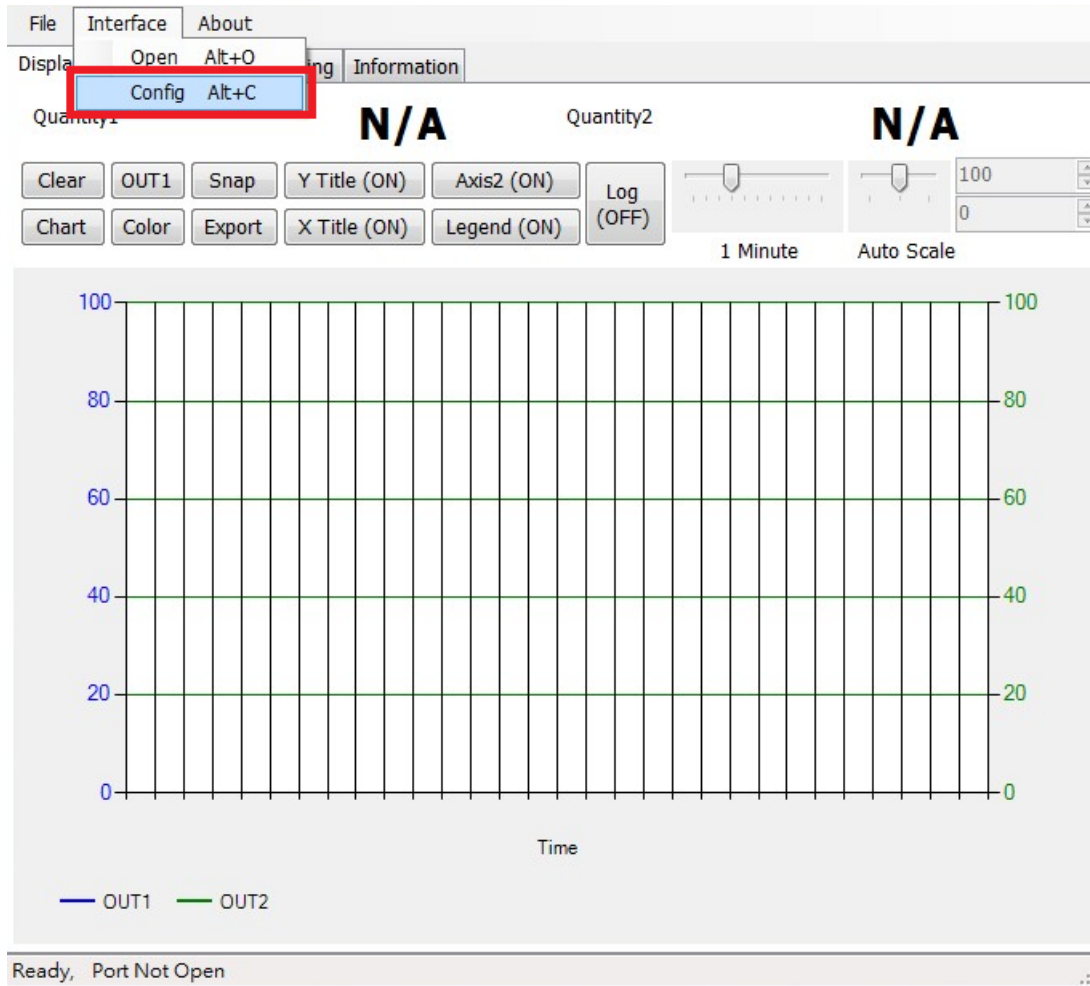

Instruction Manual

2. Select the corresponding values of com port as following
 - a. Port No of your computer used
 - b. Physical Interface: RS-485

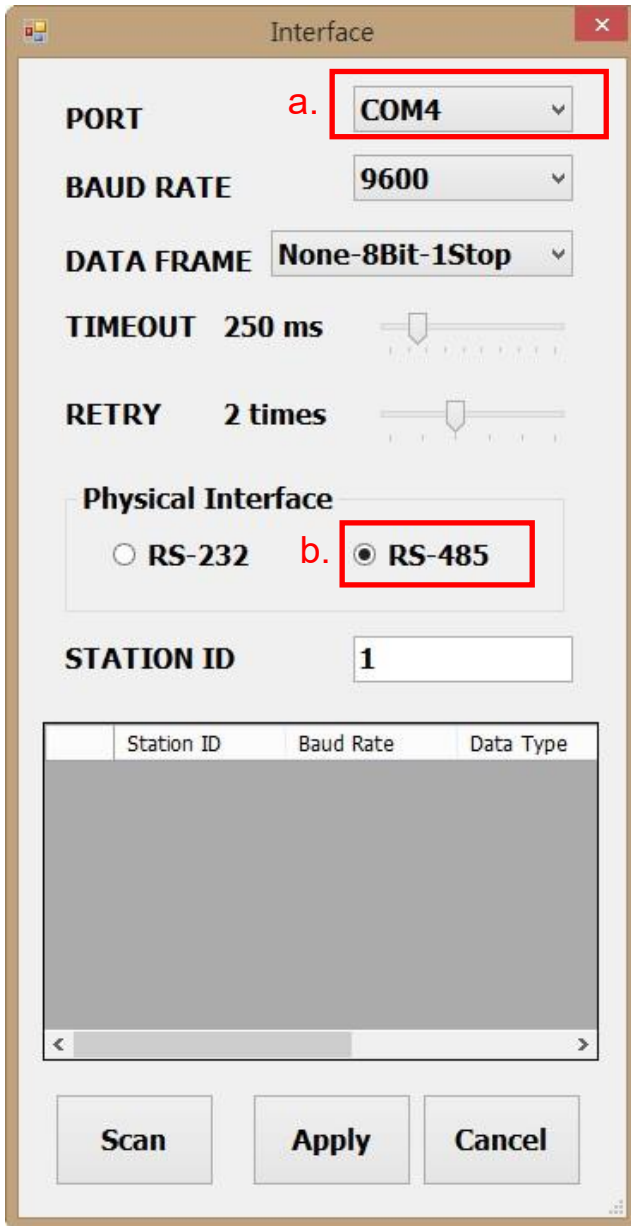

3. Click "Scan" to start scanning for connected devices

Instruction Manual

4. Once scanning is completed, connected devices are shown in the table below
 - a. Choose the Station ID that you want to edit/connect
 - b. Click "CLOSE AND EXPORT"

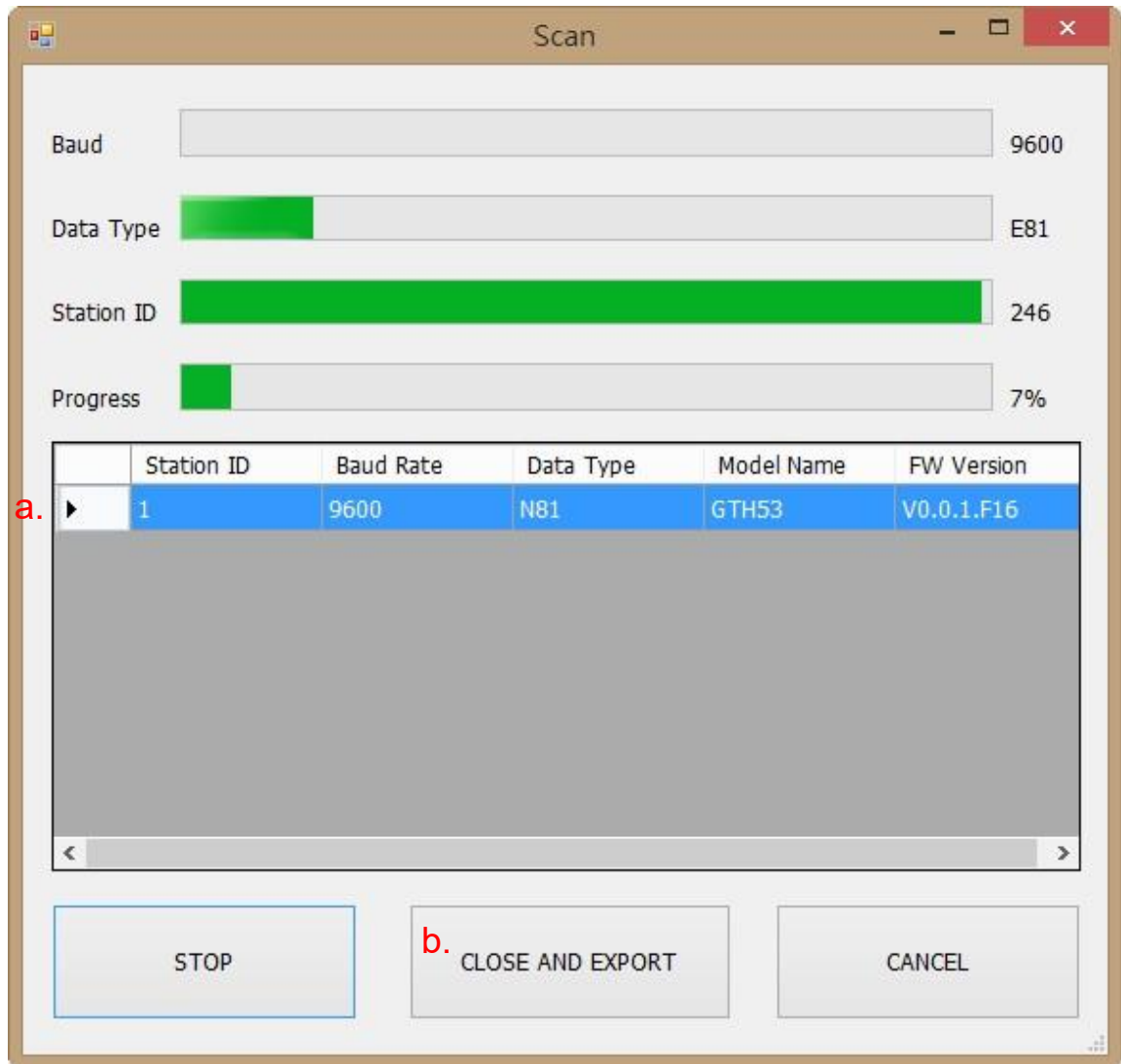

Instruction Manual

Interface

PORT **COM4**

BAUD RATE **9600**

DATA FRAME **None-8Bit-1Stop**

TIMEOUT **250 ms**

RETRY **2 times**

Physical Interface

RS-232 RS-485

STATION ID **1**

Station ID	Baud Rate	Data Type
1	9600	N81

Scan Apply Cancel

5. Click "Apply" to save the setting

Instruction Manual

6. If connection is successful, this window will appear:
 - a. Shows the current measured values
 - b. Shows “Read OUT1 Config, Read successful” in status bar

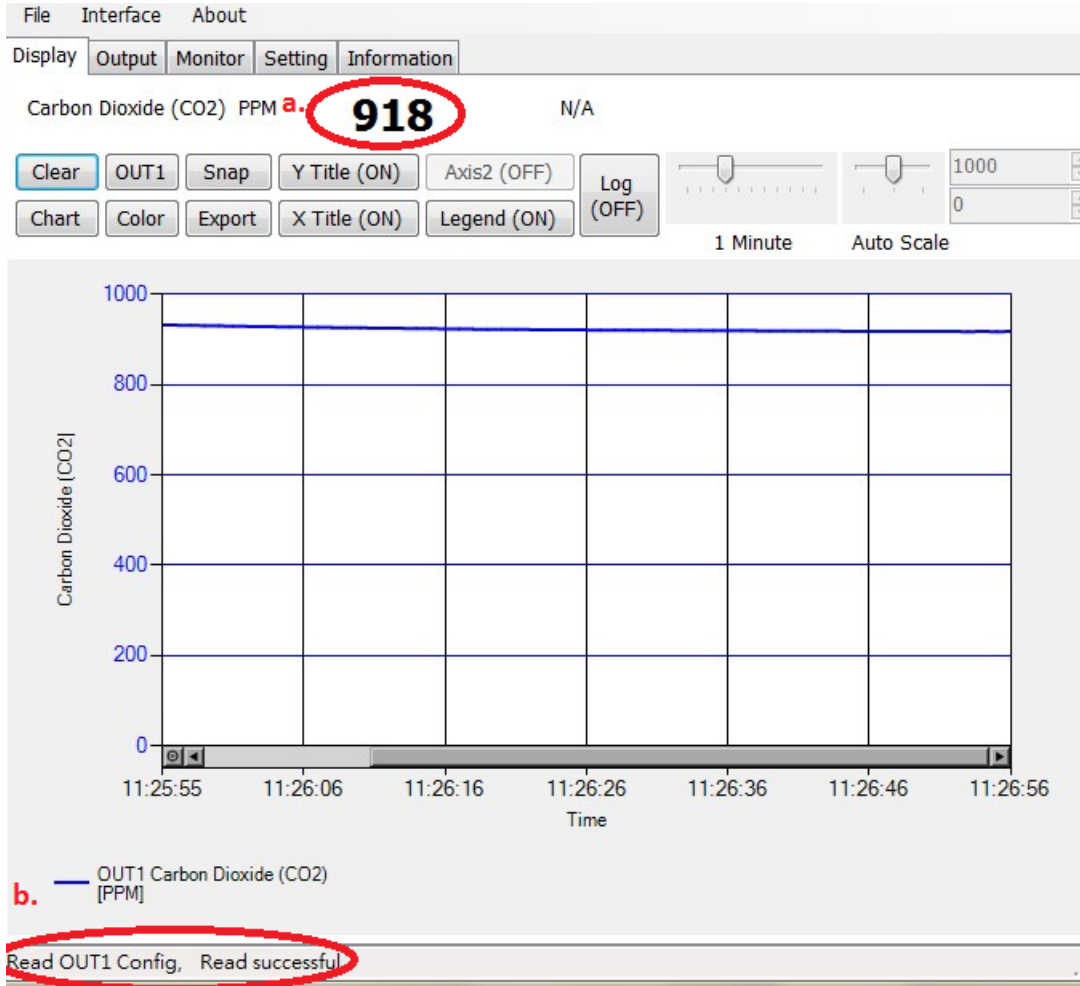

Instruction Manual

7.4 Setting RS-485 communication format

1. RS485 connection establishment according to 7.2
2. Click on "Setting"

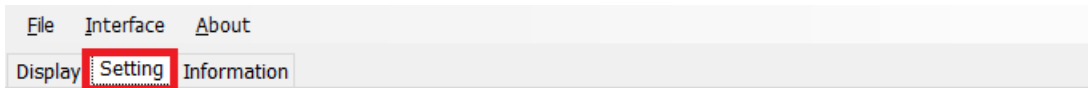

Modbus Protocol

Station ID	<input type="text" value="1"/>	Test Count:	Test Result
Baud Rate	<input type="text"/>	Write Error:	
Data Frame	<input type="text"/>	Read Error:	
		Data Error:	
		Echo Test (OFF)	Reset Counter

CO2 AutoCalib

Auto Drift Calib

Apply **Read**

Read Setting Error, Serial port not open

Instruction Manual

3. To select Modbus protocol parameter

- a. Station ID : 1~247 (default:1)
- b. Baud Rate : 9600, 19200, 38400, 57600, 115200 (default:9600)
- c. Data Frame : None-8Bit-1Stop, None-8Bit-2Stop, Even-8Bit-1Stop, Even-8Bit-2Stop, Odd-8Bit-1Stop, Odd-8Bit-1Stop

File Interface About

Display Setting Information

Modbus Protocol

Station ID a. 1

Baud Rate b.

Data Frame c.

Test Count: Write Error: Test Result
Read Error:
Data Error:

Echo Test (OFF) Reset Counter

CO2 AutoCalib

Auto Drift Calib

Apply Read

Open Port, Serial port not open

4. Click Apply save the setting

5. Then perform RS485 connection establishment according to 7.2 or 7.3

Instruction Manual

7.5 CO2 Self-Correcting ADC

1. RS485 connection establishment according to 7.2
2. Click on "Setting"

The screenshot shows a software interface with a menu bar at the top containing 'File', 'Interface', and 'About'. Below the menu bar, there are three tabs: 'Display', 'Setting', and 'Information'. The 'Setting' tab is highlighted with a red box.

The main content area is divided into two sections:

- Modbus Protocol:** This section contains three input fields: 'Station ID' (with a dropdown menu showing '1'), 'Baud Rate' (with a dropdown arrow), and 'Data Frame' (with a dropdown arrow). To the right of these fields, there are labels for 'Test Count:', 'Write Error:', 'Read Error:', and 'Data Error:'. Below these labels are two buttons: 'Echo Test (OFF)' and 'Reset Counter'.
- CO2 AutoCalib:** This section contains a single button labeled 'Auto Drift Calib'.

At the bottom of the main content area, there are two large buttons: 'Apply' and 'Read'.

At the very bottom of the interface, there is a status bar with the text 'Read Setting Error, Serial port not open' and a small icon on the right.

Instruction Manual

- To enable, click "Auto Drift Calib" under the CO2 AutoCalib

The default status set as OFF, this function is used for calibration of CO2 environment, it performs the sampling method (average value of 7 days) to implement calibration.

- This product is suitable for indoor HAVC environment as in standard apartment, office building.
- The environment has to be clean (no external influence) for over 6 hours if user attempt to turn ON this function and it is advised to turn OFF this function if the humans stay in the indoor environment for long periods.

- Click "Apply" to save the setting

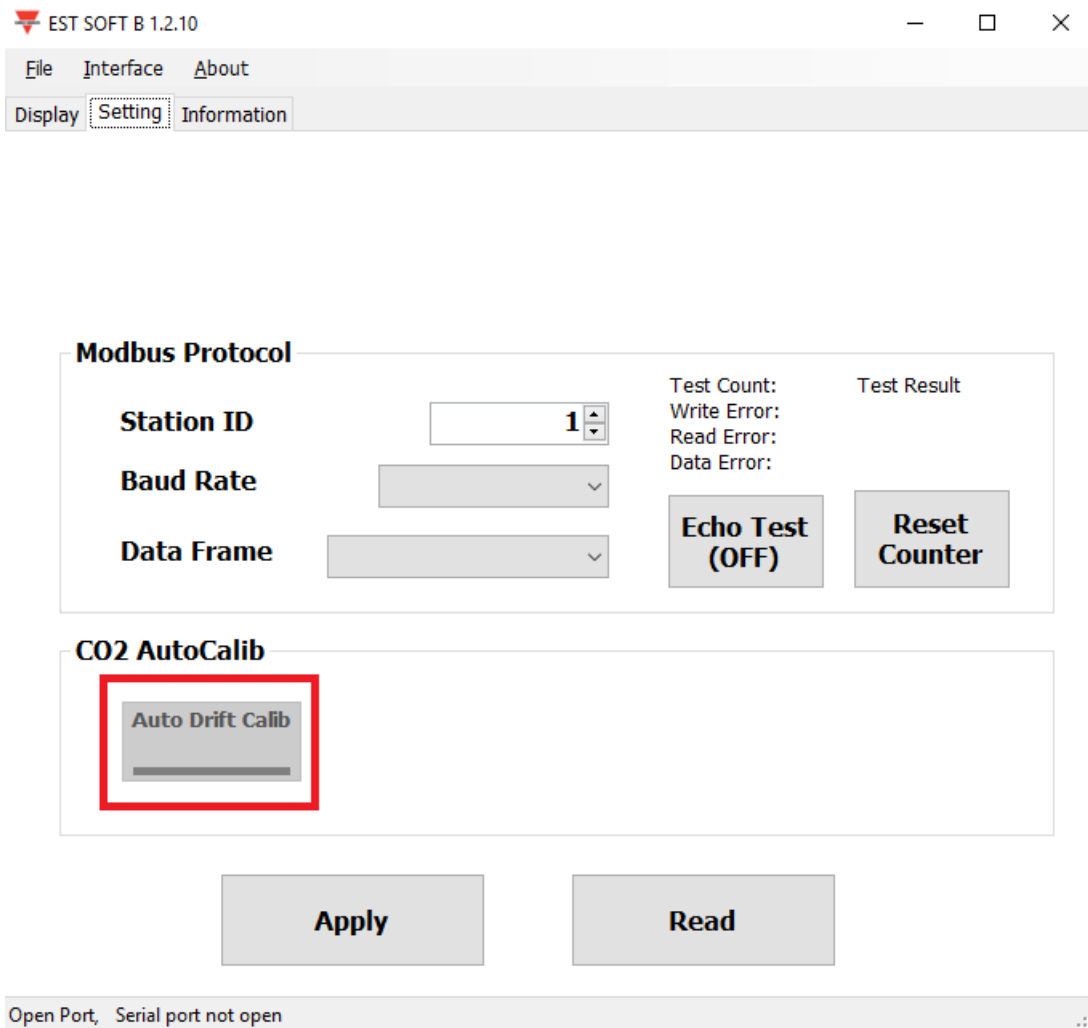

Instruction Manual

7.6 Display page

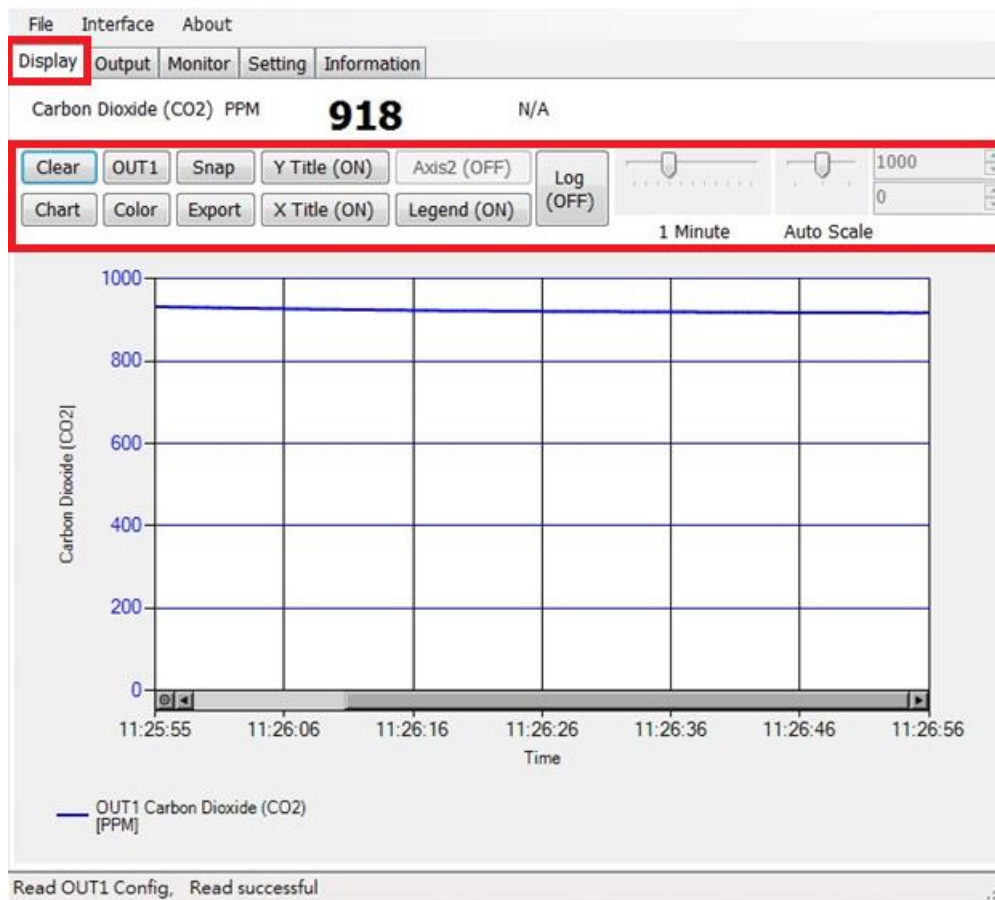

- Clear: clear the chart records
- Chart: change the chart style
- Out1: toggle between output channel
- Color: set the chart line color of the selected output channel
- Snap: print screen the chart area and can be copy to other programs
- Export: export the measurement to csv format and select location to save
- Y Title: On/off the title of Y axis
- X Title: On/off the title of X axis
- Axis 2: On/off the second axis on the right of the chart
- Legend: On/off the legend
- Log: On/off the logging and select location to save (logging interval is set at File>Log Interval)
- Auto Scale: On/off auto scale or switch to manual scale for the Y axis

Note: Not every function in this software will be available; this is depending on the product model that the software is connected to.

Instruction Manual

8. Modbus Protocol

- a. User can also use other Modbus software (such as BMS system, Modscan etc) to read data according to the Modbus protocol provided.
- b. Please download the protocol document from the Carlo Gavazzi website
- c. Modbus is a standard protocol in industry field, a common protocol between electrical equipments.
- d. Wiring Rule:
 - I. The Port No. must be different.
 - II. The maximum devices which connected to RS-485 interface restricted to 32 devices.
 - III. Transmission Rate (Baud Rate) must be the same.

Instruction Manual

9. Cautions

- a. In order to prevent the internal PCB & electric components from damage, user must not open the internal cover or if really necessary, please open with extreme care.
- b. In order to avoid damage or measuring error; do not touch or knock the high-sensitivity sensors.
- c. In order to maintain accurate measuring values. Please install product at a well-ventilated location.
- d. For the special environment, such as chemical factory or plant greenhouse, please turn OFF the CO2 Self-Correcting ADC function if the CO2 concentration stays on long term and with high concentration status.

Instruction Manual

10. Inspection and Maintenance

Maintenance & Trouble Shooting

User is not necessary to calibrate the product during installation. This product has already passed the inspection/ calibration before shipment.

1. Periodical Inspection --- According to the contamination status & density of air dust, to implement the inspection/ maintenance periodically for sensing accuracy and clean the filter.
2. Protection for High-Sensitivity Sensor --- Extreme care is required for not destroying the sensor during installation or maintenance.
3. Trouble Shooting --- Please follow the instructions for appropriate solution,

Unusual Status:	Inspection:	Procedures:
<ol style="list-style-type: none">1. No Output2. Output Unstable	<ol style="list-style-type: none">1. Disconnected Wiring.2. Wiring Loosen or disconnected.3. Confirm the voltage of power supply.4. The damage of sensors.	<ol style="list-style-type: none">1. Re-Perform the wiring2. Screw on terminal tightly or replace wires.3. Replace the sensor.
<ol style="list-style-type: none">1. Slow Response Output2. Inaccuracy	<ol style="list-style-type: none">1. Moisture/ condensation on sensor.2. Check the installed location.3. Check the dust & contamination of the product	<ol style="list-style-type: none">1. Remove the housing.2. Place the sensor in the clean/ nature air for drying.3. Clean the filter