



Soft starter Configuration Software (SCS)

for RSBT40 & RSBT48 VC versions

User Manual

Rev 2.0

Contents

Chapter 1 Introduction

1.1 Foreword	3
1.2 Product inspection	3
1.3 Precautions	3

Chapter 2 Software Installation

2.1 System requirements	4
2.2 Software setup file	4
2.2 Installing the software	4
2.3 Uninstalling the software	6

Chapter 3 Establishing Communication

3.1 Introduction	7
3.2 Installation	7
3.3 One-to-one communication	8
3.4 One-to-many communication	9
3.5 Automatic Connection	10
3.6 Manual Connection	11

Chapter 4 SCS User Interface

4.1 Software structure	13
4.2 Toolbar icons	13
4.3 Dashboard window	13
4.4 Settings window	19
4.5 Variables window	23

Chapter 5 Modbus RTU Protocol

5.1 Introduction	26
5.2 Modbus RTU functions	26
5.3 Registers Map	28

Chapter 6 Examples

6.1 Changing the communication parameters	33
6.2 Start/Stop through Modbus	34
6.3 Start/Stop using Force Refresh Signal	35

Chapter 1 Introduction

1.1 Foreword

RSBT is a 3-phase controlled softstarter with dedicated algorithm for scroll compressors. RSBT40 and RSBT48 VC versions are equipped with Modbus RTU communication over RS485.

The purpose of this document is to outline information on the functionalities that are provided by the Soft starter Configuration Software (SCS). This software can be used to initialise, control and monitor RSBT scroll compressor softstarters. Should there be any problem in using this software that cannot be solved with the information provided in this guide, contact our technical representative who will be willing to help you.

1.2 Product inspection

Please check the following when receiving and unpacking RSBT units:

- The product is the one specified in your purchase order
- Check if there are any damages caused by transportation. In case of any problem, do not install the product and contact Carlo Gavazzi sales representative.

We suggest keeping the original packing in case it is necessary to return the instrument to our After Sales Department. In order to achieve the best results with your product, we recommend reading the instruction manual carefully. If the product is used in a way not specified by the producer, the protection provided by the product may be impaired.

1.3 Precautions

For your safety, the following symbol is to remind you to pay attention to safety instructions on configuring and installing RSBT. Be sure to follow the instructions for higher safety.



This symbol indicates a particularly important subject or information

Please read this manual thoroughly before using the device. Should there be any problem using the product which cannot be solved with the information provided in the manual, contact your nearest Carlo Gavazzi distributor or our sales representatives to help you. Check that the device is installed in accordance with the procedures as described in this manual.

The manufacturer accepts no liability for any consequence resulting from inappropriate, negligent or incorrect installation or adjustment of the optional parameters of the equipment. The contents of this guide are believed to be correct at the time of printing. In the interests of commitment to a policy of continuous development and improvement, the manufacturer reserves the right to change the specification of the product or its performance, or the content of the guide without notice.

Chapter 2 Software Installation

2.1 System requirements

Software configuration software is designed to run on Microsoft Windows.

- Windows 7
- Windows 8/8.1
- Windows 10
- Mac OS

2.2 Software setup file

If the PC meets the above system requirements, you can download the latest version of the setup_SCS_1.0.zip from our website (http://gavazziautomation.com/nsc/HQ/EN/soft_starters).

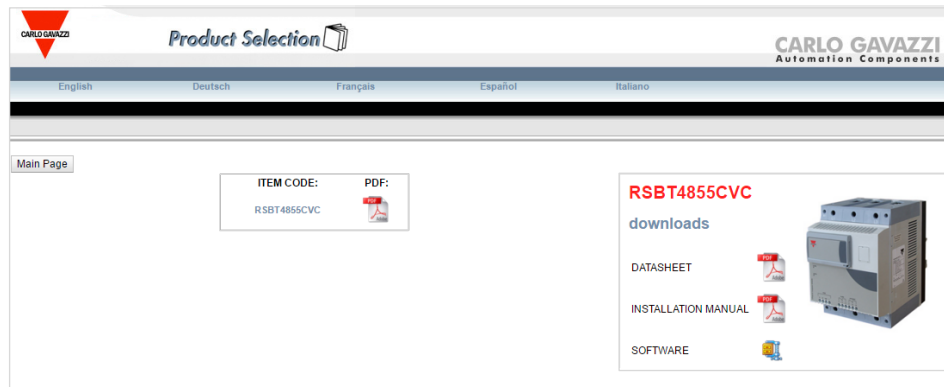

2.2 Installing the software

If the setup file is downloaded successfully, you can start installing the software by unzipping the file and then run the setup.msi file. The following window will appear:

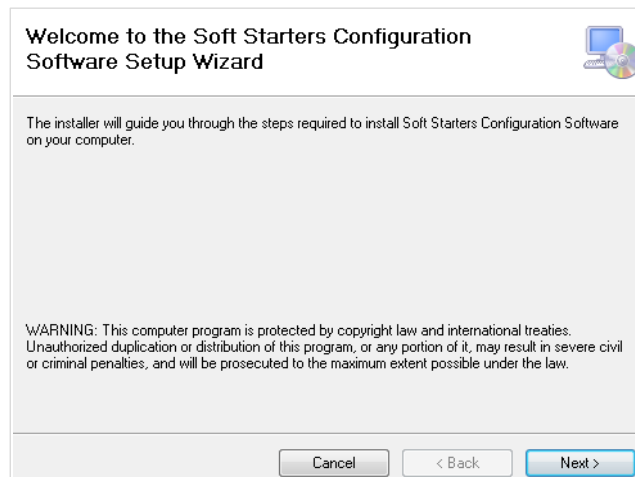

Click next to progress through the Install Wizard and install the Soft Starters Configuration Software.

Choose a location to install the software or click next to continue with the default location.

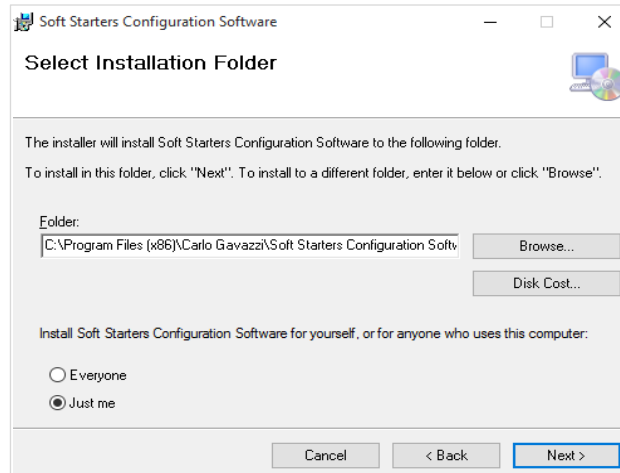

Click next to start the installation.

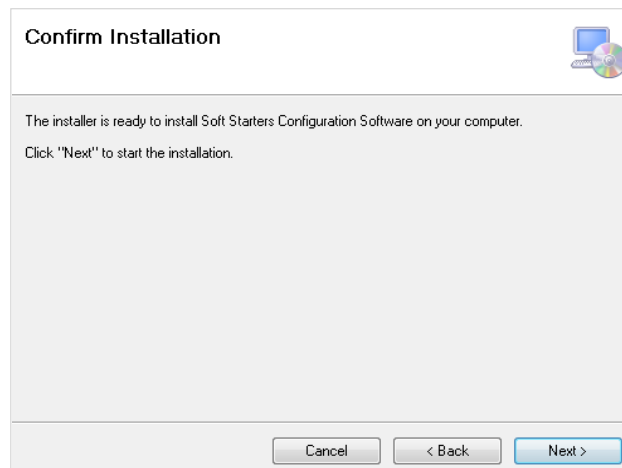

Once the installation is complete, you should see the Carlo Gavazzi logo on your desktop. Double click to open the software. The following screen will appear:

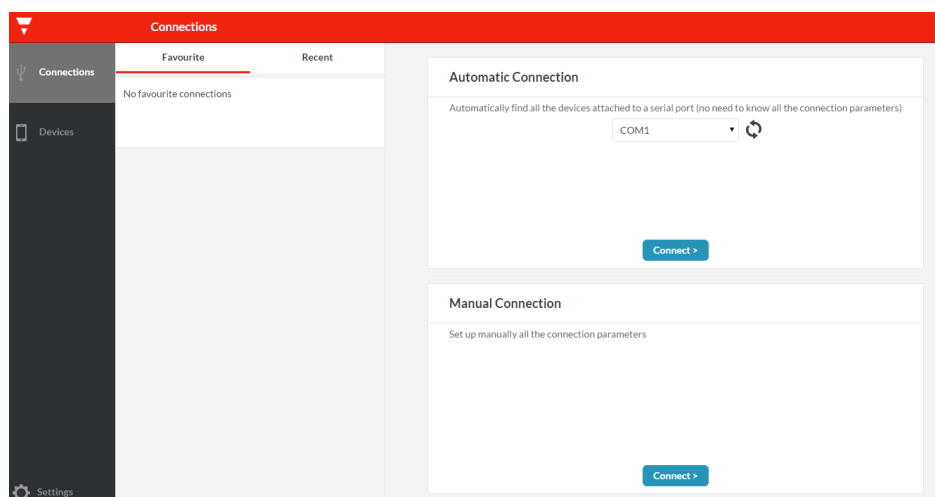

2.3 Uninstalling the software

When you uninstall the software, the files installed by SCS will be removed from your PC.

The following steps instruct you to uninstall the software from your PC.

- Open the Control Panel in Windows and under Programs, click on Uninstall a program
- Select the software configuration software and click on Uninstall

Chapter 3 Establishing Communication

3.1 Introduction

The RSBT can be controlled either by a PC or by a controller using Modbus RTU protocol, with one-to-one or one-to-many communication. The Modbus link between the master and slaves can be established on a 3-wire RS485 communication port.

The RSBT soft starters leave the factory with default communication parameters as listed below:

Default communication parameters	
Parameter	Default Value
Device address	1
Baud rate	9600
Parity	No parity
Stop Bit	1



The factory default communication parameters can be modified through the software as will be explained in Chapter 4.

3.2 Installation

In order to be able to establish communication between a PC with SCS (or a controller) and a scroll compressor soft starter, you will need to connect a raw cable between the communicating device and the screw terminal (A(-), B(+), GND) on the RSBT unit.

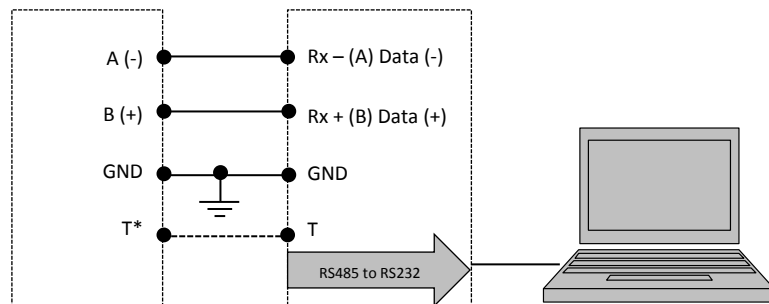

* Note: The "T" terminal is only available for the RSBT48 unit.

The A (-) and the B(+) connections from the softstarter need to be connected to the Rx- (A) and Rx+ (B) line of the communicating device respectively. If this connection is not followed, communication will not be established.



To reduce noise on the RS485 communication raw cable, use a twisted pair and shielded cable. In addition, connect the shield to the GND terminal to further minimize the noise on the RS-485 cable.

3.3 One-to-one communication

One-to-one communication occurs between a PC with SCS (or a controller) and a soft starter.

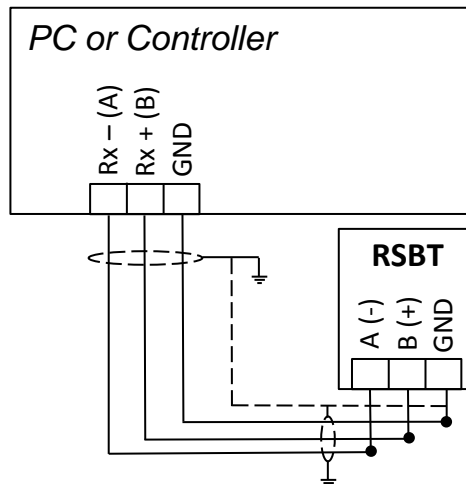

In order to establish one-to-one communication, the RSBT unit must be first powered-up with the specified supply voltage.

If the supply LED is green fixed on the soft starter, you can run the SCS by clicking on the corresponding icon and the following window will appear.

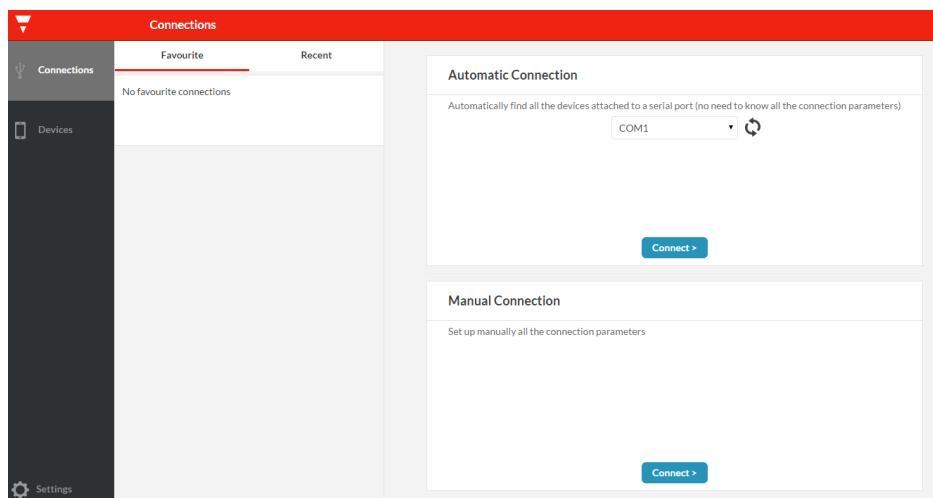



The software provides two methods to establish one-to-one communication:

- a. Automatic connection (*more details in section 3.5*)
- b. Manual connection (*more details in section 3.6*)

3.4 One-to-many communication

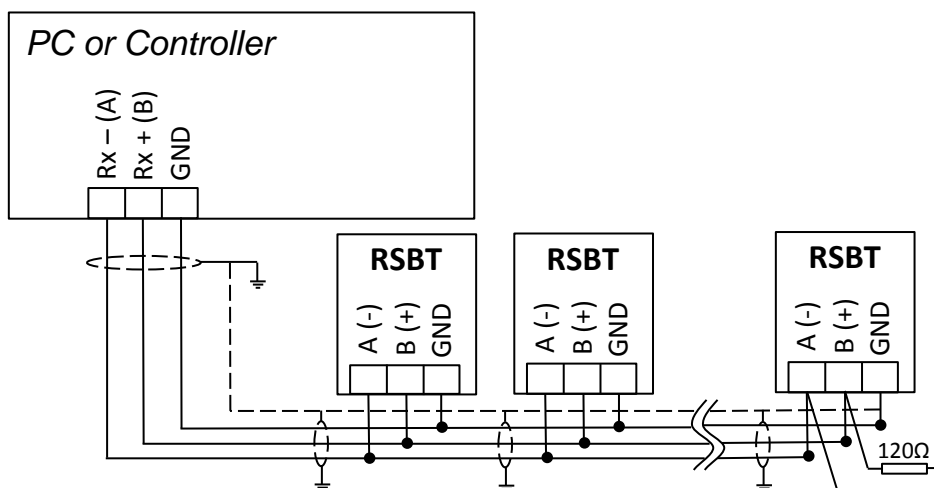
One-to-many communication occurs between a PC with SCS (or a controller) and multiple soft starters.



 In order to establish one-to-many communication, the RSBT units must be first all powered-up with the specified supply voltage.

If the supply LED is green fixed on all soft starters, you can run the SCS by clicking on the corresponding icon and the following window will appear.

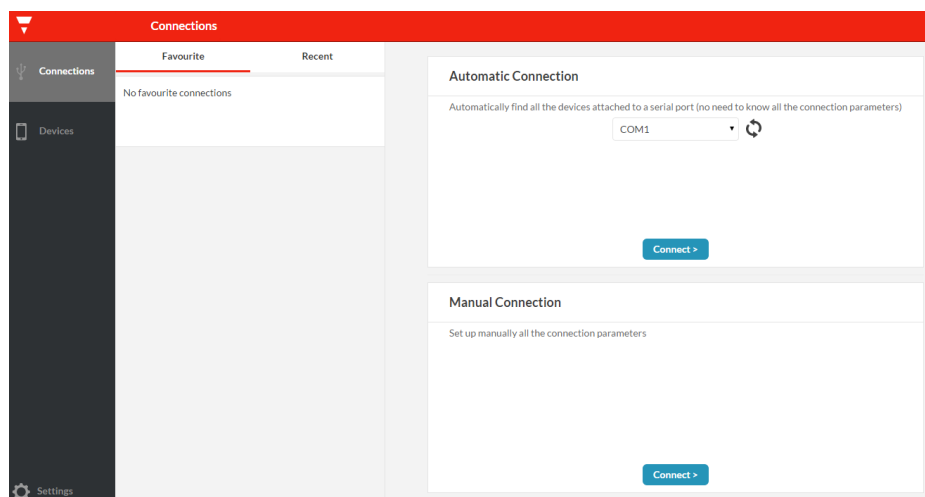

The software provides two methods to establish one-to-many communication:

- a. Automatic connection (*more details in section 3.5*)
- b. Manual connection (*more details in section 3.6*)

 For one-to-many communication, the device address of each RSBT should be different. This parameter can be modified through the software as will be explained in Chapter 4.



For one-to-many communication, the baud rate and parity bit of each RSBT should be the same. These parameters can be modified through the software as will be explained in Chapter 4.



For large networks, it is required to place a 120Ω ¼W resistor between A (-) and the B(+) connections on the last softstarter, to avoid possible communication problems.

3.5 Automatic Connection

The automatic connection is useful when the communication parameters mentioned in Section 3.1 are unknown.

The following procedure must be followed to establish communication:

- Select the serial port that you will be using on the PC

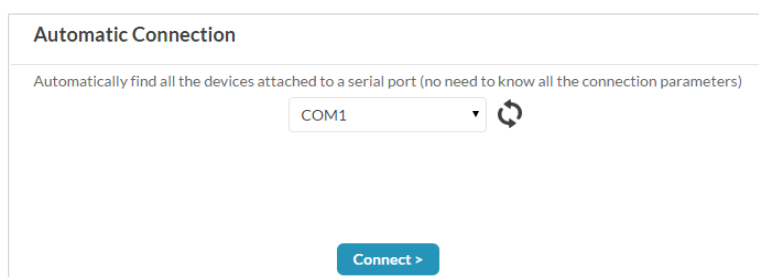

- Click on the *Connect* icon

The software starts to find all the devices attached to the serial port.

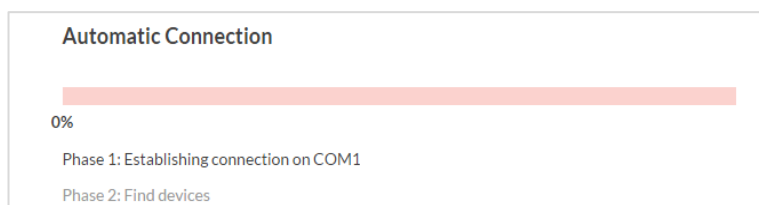

If connection is successful, the following window will appear if you have established:

- a. *One-to-one communication*

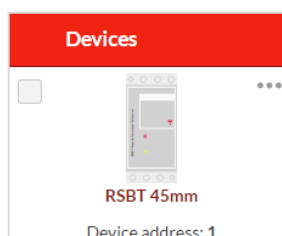

b. One-to-many communication



In the event that communication is not established, the following message will be displayed:

No devices found with the given parameters

Please check that the following conditions are satisfied before trying to re-establish communication:

- ✓ RSBT softstarter/s is/are powered-up (Green fixed LED)
- ✓ RS485 port is properly connected
- ✓ Communication settings are correct

3.6 Manual Connection

The manual connection is used when the communication parameters mentioned in Section 3.1 are known.

The following procedure must be followed to establish communication:

- Click on the *Connect* icon

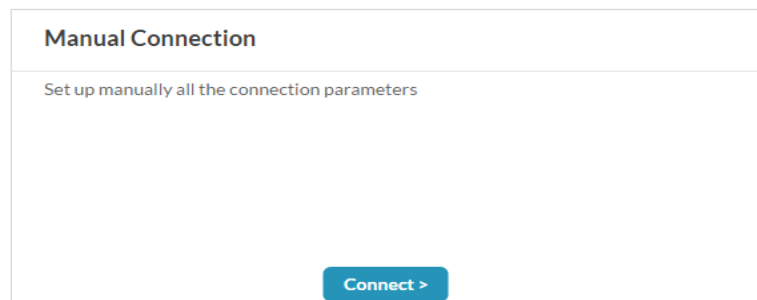

- Enter the relevant communication parameters and click on the *Connect* icon

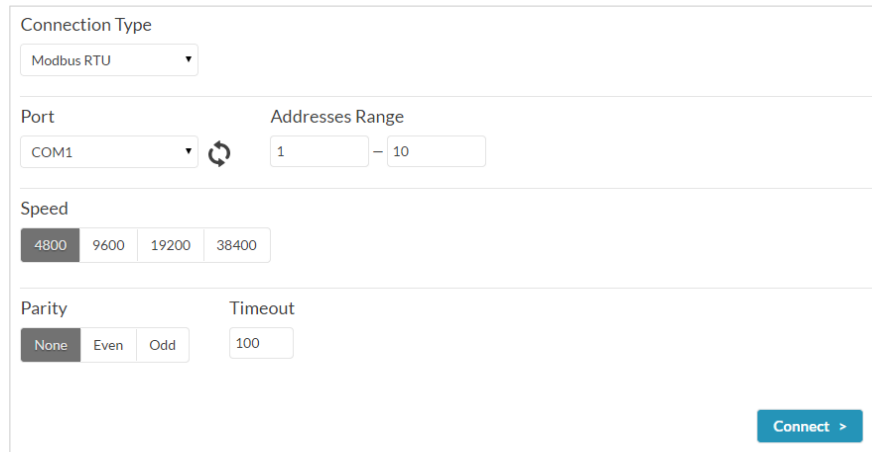

If connection is successful, the following window will appear if you have established:

- a. *One-to-one communication*

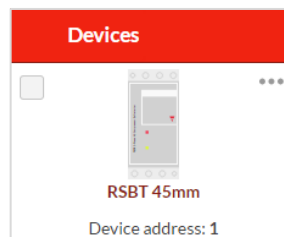

- b. *One-to-many communication*



In the event that communication is not established, the following message will be displayed:

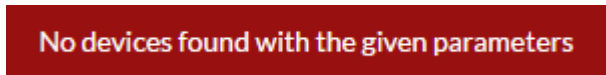

Please check that the following conditions are satisfied before trying to re-establish communication:

- ✓ RSBT softstarter/s is/are powered-up (Green fixed LED)
- ✓ RS485 port is properly connected
- ✓ Communication settings are correct

Chapter 4 SCS User Interface

4.1 Software structure

The soft starter configuration software can be used to initialise, control and monitor RSBT soft starters. It consists of three main windows:





- *Dashboard*
- *Settings*
- *Variables*



The three main windows of the SCS can only be accessible when the PC establishes communication with the device.

4.2 Toolbar icons

The user interface has different icons in the toolbar in order to choose among the main windows of the software.

Toolbar icons	
Icon	Description
	Open the <i>Dashboard</i> window
	Open the <i>Settings</i> window
	Open the <i>Variables</i> window
	Navigate to a previously viewed window
	Disable live preview

4.3 Dashboard window

The *Dashboard* window is the main screen of the soft starter configuration software. This window can be used to select the soft starter that you want to work with when having one-to-many communication. Furthermore, it provides several functions which are designed specifically to control and monitor the selected device.

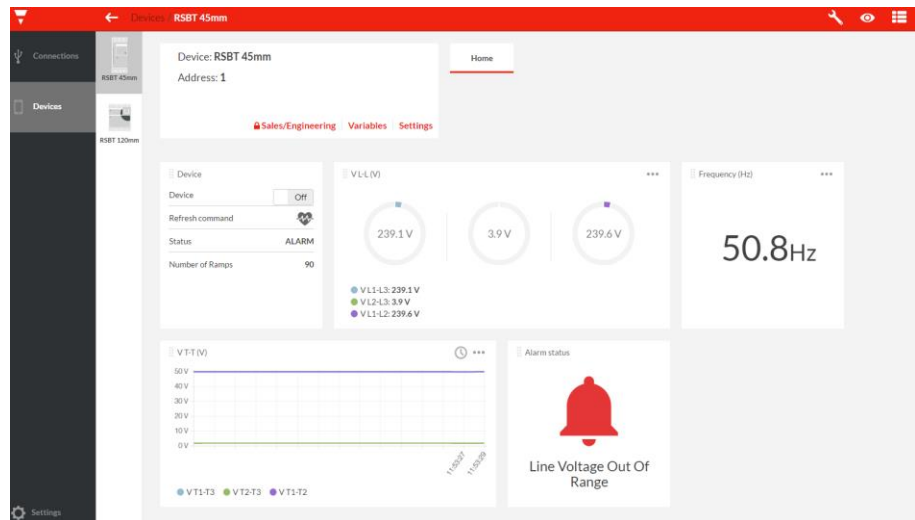

The functions provided by the *Dashboard* window are:

a. *Device*

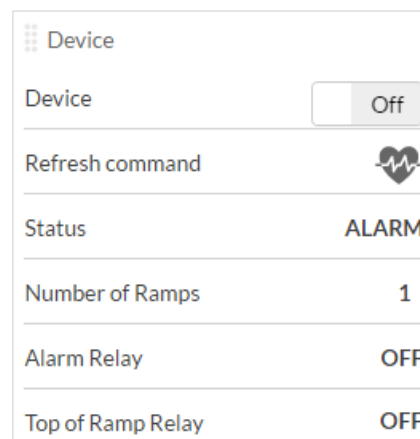

This function consists of:

➤ *Device On/Off command*

This command can be used to switch On/Off the control/start signal, if the *Control Mode* is set to Modbus control.



The *Control Mode* parameter can be modified through the software from the *Settings* window under the *Inputs* section.



If this command is ON, as soon as the soft starter resets from an alarm, the load will switch ON.

➤ *Refresh command*

When *Start Command Refresh* is enabled, the soft starter expects a *Refresh* command to be sent within the *Refresh Interval* that can be set by the user. If this command is not sent during the *Refresh Interval*, then the soft starter assumes that communication has been lost and will switch OFF the load.



The *Start Command Refresh* and *Refresh Interval* parameters can be modified through the software from the *Settings* window under the *Inputs* section.

➤ *Status of soft starter*

The status of the soft starter can be:

- ✓ *IDLE*
- ✓ *BYPASS*
- ✓ *ALARM*
- ✓ *RECOVERY*



The soft starter will not respond to a start command if it is in *Alarm* or *Recovery* state.

➤ *Number of ramps*

This variable indicates the number of ramps (i.e. the number of starts) that the soft starter has successfully accomplished.

➤ *Status of Alarm Relay*

This variable indicates whether or not the soft starter is in alarm condition.

➤ *Status of Top of Ramp Relay*

This variable indicates whether or not the soft starter is in bypass mode.



The relay outputs are only available for the RSBT48 unit.

b. *Voltage & Current Monitoring*

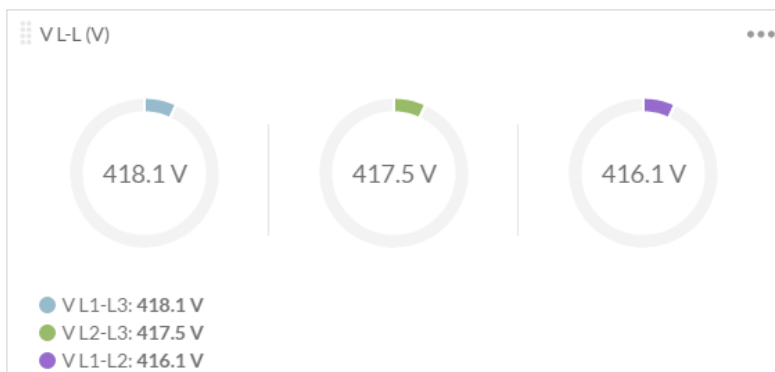

This function monitors either one of the following variables:

- Line-to-Line voltage (V)
- Terminal voltage (V)
- Line current (A)

To select between the aforementioned variables, you must click on the upper right-hand corner of the widget and the following screen will appear:

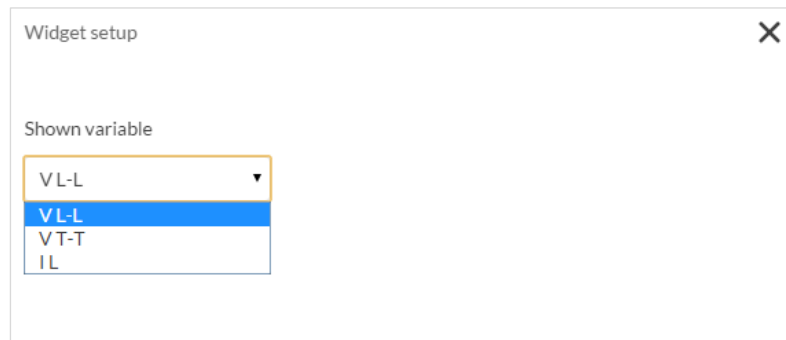

The line current is not available for the RSBT40 unit but can be found in the power monitoring function

c. Power Monitoring



This function monitors either one of the following variables:

- Frequency (Hz)
- Total power (W)
- Total apparent power (VA)
- Power factor (PF)
- Power (kWh)
- I L3 (A)

To select between the aforementioned variables, you must click on the upper right-hand corner of the widget and the following screen shall appear:

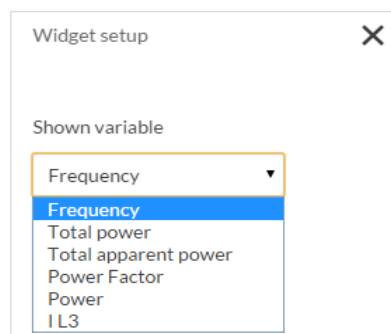

The line current is only available for the RSBT40 unit.

d. Scope



This function works the same way as an oscilloscope and it can monitor either one of the following variables:

- Line-to-Line voltage (V)
- Terminal voltage (V)
- Line current (A)

To select between the aforementioned variables, you must click on the upper right-hand corner of the widget and the following screen will appear:

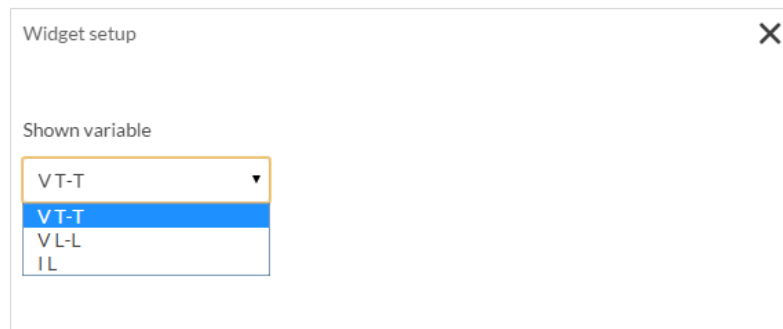

e. Alarm Status

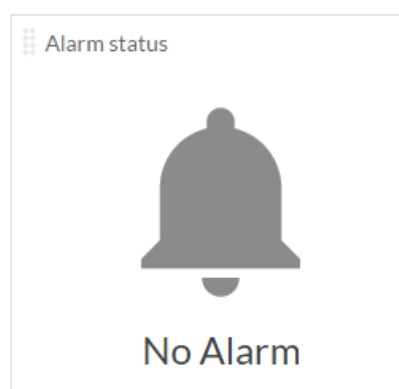

If one of the eight alarms mentioned in *Variables* window is triggered the following screen will appear:

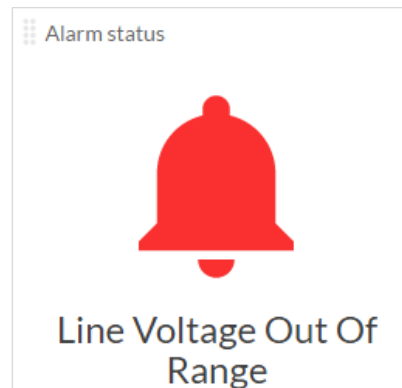

The softstarter will not respond to a start command if it is in Alarm state.

f. *Sales/Engineering*

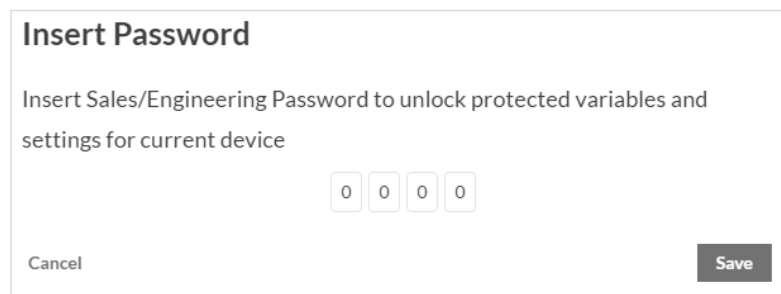

Insert Password

Insert Sales/Engineering Password to unlock protected variables and settings for current device

0 0 0 0

Cancel Save

The following variables and settings are password protected:

- I_{MIN} Bypass (A)
- I_{MAX} Bypass (A)
- Maximum Current in HP Ramp (A) (available for RSBT40 unit)
- HP Ramp (%) (available for RSBT48 unit)
- Device Starts History
- Alarm Counters

To unlock these variables and settings, you must enter the correct access code.



The access code can be obtained from Carlo Gavazzi sales support.

If the access code is incorrect, the following message will be displayed:

The inserted password is not valid

4.4 Settings window

The *Settings* window lists the programmable parameters available for the RSBT units. If you want to customise the unit for your own application, you will have to change the default factory parameter settings.

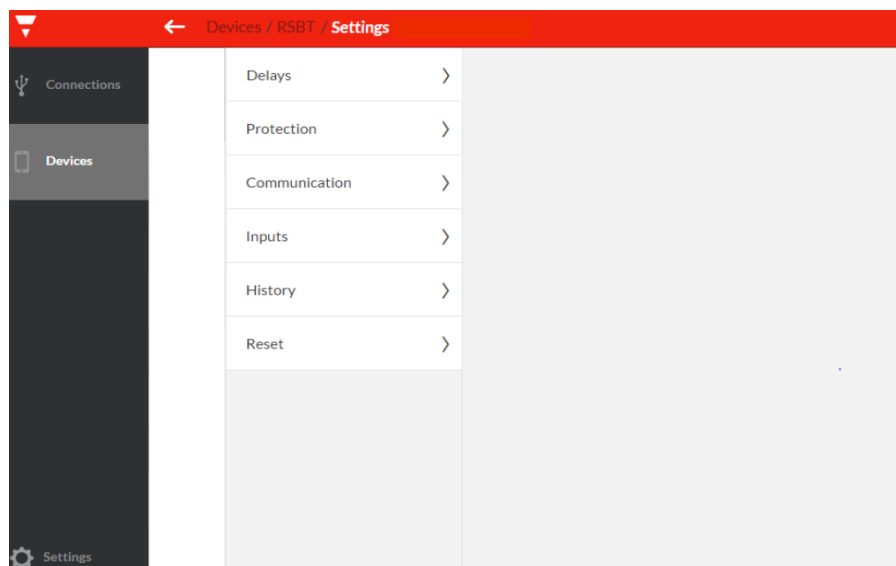

Make sure that the RSBT is in idle state while parameters are modified.

The functions provided by the *Settings* window are:

a. Delays

This function contains the delays related to stop-to-start and start-to-start intervals that can be modified by the user. The user can also visualise the time from last start.



Minimum stop to start delay (s)	<input type="text" value="60"/>
Minimum start to start delay (s)	<input type="text" value="60"/>
Time from last start (s)	32
<input type="button" value="Save"/>	



It is up to the user to make sure that the maximum starts/hr that the RSBT unit can handle is not exceeded.

b. Protection

In this function, the user can visualise and modify a set of alarm limits. Furthermore, the user may select to enable or disable the *Auto Adapt* function. For further information about this function please refer to the product datasheet.

Supply Voltage Unbalance (%)	<input type="text" value="20"/>
Over Voltage Alarm (V)	<input type="text" value="580"/>
Under Voltage Alarm (V)	<input type="text" value="180"/>
I min Bypass (A)	 Requires Engineering Access Level
I max Bypass (A)	 Requires Engineering Access Level
I max Current Limit(A)	<input type="text" value="192.5"/>
HP Ramp (%)	 Requires Engineering Access Level
Auto Adapt	<input type="text" value="On"/>
<input type="button" value="Save"/>	

Variables I_{MAX} Bypass and I_{MAX} Current Limit are device dependent. A value higher than the default will cause the device to fail and the following message shall display:

An error has occurred while saving the settings

Therefore, make sure that the value of these two variables does not exceed the default value.

Device	Version	I _{MAX} Bypass (A _{rms})	I _{MAX} Current Limit (A _{rms})
RSBT40	16A	19.0	40.0
	25A	29.0	90.0
	32A	40.0	130.0
RSBT48	55A	60.0	192.5
	70A	75.0	245.0
	95A	100.0	332.5

c. *Communication*

In this function, the user can visualise and modify the communication parameters. The default communication parameters can be found in Chapter 3 Section 3.1.

Device Address	<input type="text" value="1"/>
RS485 baud rate (bit/s)	<input type="text" value="9600"/>
RS485 parity	<input type="text" value="No parity"/>
<input type="button" value="Save"/>	



Baud Rate 4800bit/s is only available for the RSBT48 unit.



The communication parameters become effective only when the RSBT unit is turned OFF and ON.

d. *Inputs*

In this function, the user can select the *Control Mode* (Modbus or A1 A2 mode) and can also enable/disable the *Start Command Refresh* (a.k.a. heartbeat signal).

Control Mode	<input type="text" value="Modbus Mode"/>
Start Command Refresh	<input type="text" value="Off"/>
Refresh Interval (s)	<input type="text" value="5"/>
<input type="button" value="Save"/>	



The factory default *Control Mode* is set to A1-A2 mode.



If the *Start Command Refresh* is disabled, the load remains switched ON in case communication is lost.

e. *History*

In this function, the user can download a history file (either in Excel (.xlsx) or CSV (.csv) format) which contains information about the last 32 starts performed. For further information on the content of the history file we advise you to contact Carlo Gavazzi sales support.

Download device starts history

[Download \(.xlsx\)](#) [Download \(.csv\)](#)



The *Initial Firing Angle* variable is only available for the RSBT48 unit.

If the user does not enter the access code before downloading the history file, the following message shall display:

You need to insert a valid access code to download the history from this device

f. *Reset*

If an alarm is triggered, the *Soft Alarm Reset* can be used to reset the alarm manually.

Soft Alarm reset

[Reset](#)



In the case of two consecutive alarms for *Ramp-up Time >1sec* and *Locked Rotor (during Ramping)*, the soft-reset function will not reset the alarm. In order to reset the alarm, the user has to turn OFF and ON the RSBT unit.

4.5 Variables window

The *Variables* window lists the instantaneous variables and the counters available for the RSBT units.

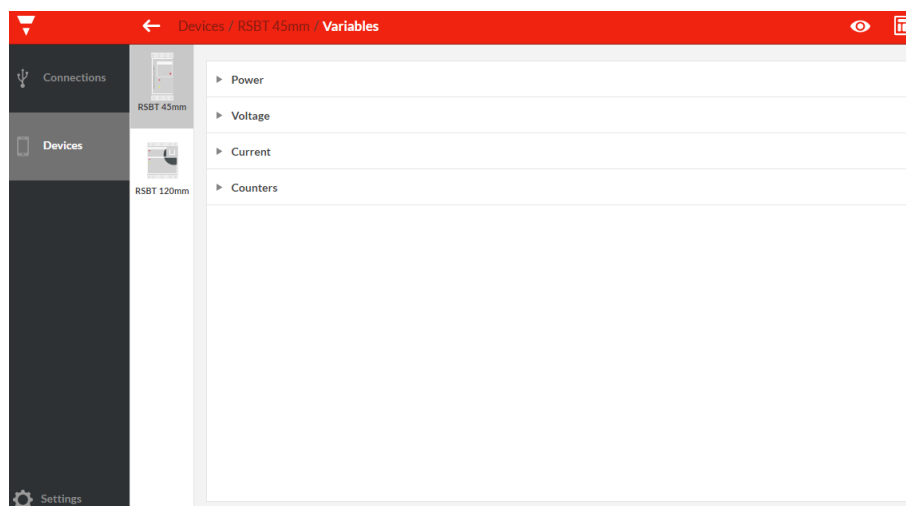

The functions provided by the *Variables* window are:

a. *Power Monitoring*

▼ Power	
W	700 W
VA	3671 VA
PF	0.19
Hz	50.8 Hz
kWh	0 kWh

b. *Voltage Monitoring*

▼ Voltage	
VL1-L3	417.0 V
VL2-L3	416.5 V
VL1-L2	414.6 V
VT1-T3	417.0 V
VT2-T3	416.4 V
VT1-T2	414.7 V

c. *Current Monitoring*

▼ Current	
IL1	16.5 A
IL2	16.5 A
IL3	16.5 A



The line current I L1 and I L2 are not available for the RSBT40 unit.

d. *Counters*

The RSBT units have two types of counters:

i. Number of Ramps counter

This counter illustrates the number of complete ramps that the soft starter has performed. A complete ramp is counted once the soft starter goes into bypass state.



If an alarm is triggered during ramp-up, the counter will not increment.

ii. Alarm counters

➤ *Wrong Phase Sequence*

If the connection to the soft starter is not done in the correct sequence (L1, L2, L3), the RSBT will trigger the wrong phase sequence alarm and the motor will not be started.

➤ *Line Voltage Out of Range*

If the measured supply voltage level is not between limits (-20%, +20%) for more than 1sec then the line voltage out of range alarm will be triggered.

➤ *Frequency Out of Range*

If the mains frequency is out of range ($f < 45\text{Hz}$ or $f > 65\text{Hz}$) then the frequency out of range alarm will be triggered.

➤ *Locked Rotor (during Ramping)*

If a current $\geq 4xI_e$ for 1sec is detected, the RSBT will trigger the locked rotor alarm.

➤ *Ramp Up Time > 1 sec*

If after 1sec, ramp up is not achieved, the RSBT will shut down and trigger the ramp up time alarm.

➤ *Over Temperature*

The RSBT constantly measures its internal temperature. If the maximum internal temperature is exceeded (for a minimum of 0.5sec) an over-temperature alarm is triggered. This condition can be triggered by too many starts per hour, an over-load condition during starting and/or stopping or a high surrounding temperature.

➤ *Over Current (during Bypass)*

In bypass mode, if there is an overcurrent ($>I_e + 15\%$ for $\geq 1\text{sec}$), the RSBT will shut down and trigger the over current alarm.

➤ *Supply Voltage Unbalance*

The RSBT measures the voltages on all the three phases and if there is a difference of more than 10% for $\geq 1\text{sec}$ between any of the phases, the RSBT will trigger the voltage unbalance alarm.



The soft starter will not respond to a start command if it is in Alarm state.



Real-time alarm visualisation is also available on the RSBT units. The alarm indicator (red LED) flashes in a specific sequence depending on the alarm that is present.

Chapter 5 Modbus RTU Protocol

5.1 Introduction

Modbus RTU protocol is a messaging structure used to establish master-slave communication between devices in which only one device (called master) can initiate transactions (called queries); the other devices (called slaves) respond with the requested data to the master.

5.2 Modbus RTU functions

The following Modbus functions are available on the RSBT softstarters:

- Reading of n “Input register” (code 04h)
- Writing of one “holding register” (code 06h)
- Broadcast mode (code 00h)

In this document, the Modbus address field is indicated in two modes:

- *Modicon address*: it is the 6-digit Modicon representation with Modbus function code 04h (Read input registers).
- *Physical address*: it is the word address value included in the communication frame.

Read Input Registers (04h):

This function code is used to read the contents of a 1 input register (word). The request frame specifies the starting register address and the number of registers to be read.

The register data in the response message is packed as two bytes per register (word), with the binary contents right justified within each byte. For each register, the first byte contains the high order bits (MSB) and the second contains the low order bits (LSB).

The only exceptions are:

- Reading of 32bit variables (Physical address: 21h and 22h)
- History file readout

Request Frame:

Description	Length	Value	Note
Physical Address	1 byte	1h to F7h (1 to 247)	-
Function Code	1 byte	04h	-
Starting Address	2 bytes	000Bh to 00E8h	Byte order: MSB, LSB
Quantity of Registers (N word)	2 bytes	1h to 78h (1 to 120)	Byte order: MSB, LSB – As stated above no contiguous registers can be read. The values 1 to 78h are the minimum and maximum numbers respectively that are accepted. Each read function should be separately called using the number stated in the field named 'Length (words)'.
CRC	2 bytes	-	-

Response Frame (correct action):

Description	Length	Value	Note
Physical Address	1 byte	1h to F7h (1 to 247)	-
Function Code	1 byte	04h	-
Byte Count	1 byte	N word * 2	-
Register Value	N* 2 bytes	-	Byte order: MSB, LSB
CRC	2 bytes	-	-

Response Frame (incorrect action):

Description	Length	Value	Note
Physical Address	1 byte	1 to F7 (1 to 247)	-
Function Code	1 byte	84h	-
Exception Code	1 byte	01h, 02h, 03h	Possible exception: 01h: illegal function 02h: illegal data address 03h: illegal data value
CRC	2 bytes	-	-

Write Single Holding Register (06h):

This function code is used to write a single holding register. The Request frame specifies the address of the register (word) to be written and its contents.

The correct response is an echo of the request, returned after the register contents have been written.

Request Frame:

Description	Length	Value	Note
Physical Address	1 byte	1 to F7 (1 to 247)	-
Function Code	1 byte	06h	-
Starting Address	2 bytes	0000h to FFFFh	Byte order: MSB, LSB
Quantity of Registers (N word)	2 bytes	0000h to FFFFh	Byte order: MSB, LSB
CRC	2 bytes	-	-

Response Frame (correct action):

Description	Length	Value	Note
Physical Address	1 byte	1 to F7 (1 to 247)	-
Function Code	1 byte	06h	-
Starting Address	2 bytes	0000h to 00E3h	Byte order: MSB, LSB
Register Value	2 bytes	0000h to FFFFh	Byte order: MSB, LSB
CRC	2 bytes	-	-

Response Frame (incorrect action):

Description	Length	Value	Note
Physical Address	1 byte	1 to F7 (1 to 247)	-
Function Code	1 byte	86h	-
Exception Code	2 bytes	01h, 02h, 03h	Possible exception: 01h: illegal function 02h: illegal data address 03h: illegal data value
CRC	2 bytes	-	-

Broadcast Mode (00h)

In broadcast mode the master can send a request (command) to all the slaves. No response is returned to broadcast requests sent by the master. It is possible to send the broadcast message only with function code 06h and using address 00h.

5.3 Registers Map

Data Format Representation

Format	IEC data type	Description	Bits	Range
UINT16	UINT	Unsigned integer	16	0...65535
UINT32	UDINT	Unsigned double integer	32	0...2 ³² -1

Group Description

Group	Description
Communication Parameters	Includes the communication parameters of the device
Device Status	Describes the status of the softstarter and other parameters of the device
Control	Includes several functions to control the device
Delays	Includes the delays related to stop-to-start and start-to-start intervals
Protection Settings	Indicates the default alarm limits
History File	Contains information about the last 32 starts performed
Instantaneous Variables	Lists the instantaneous voltage, current and power variables
Counters	Includes counters related to operational use

Communication Parameters

Read only mode (function 04h):

Modicon Address	Physical Address	Length (words)	Description	Data Format	Notes [Scaling Factor]
400057	0038h	1	Device Address	UINT16	Device Address [x1] 0001h: Device Address 1 0002h: Device Address 2 . . 00F7h: Device Address 247
400041	0028h	1	Baud Rate	UINT16	Baud Rate [x1] 0000h: 4800bps 0001h: 9600bps 0002h: 19200bps 0003h: 38400bps
400077	004Ch	1	Parity	UINT16	Parity [x1] 0000h: No Parity, 2 stop bits 0001h: Odd Parity, 1 stop bit 0002h: Even Parity, 1 stop bit

* Not available in RSBT40 unit

Write only mode (function 06h):

Modicon Address	Physical Address	Length (words)	Description	Data Format	Notes [Scaling Factor]
300113	0070h	1	Device Address	UINT16	Range: 0001h to 00F7h [x1]
300105	0068h	1	Baud Rate	UINT16	12C0h: Baudrate 4800 [x1]* 2580h: Baudrate 9600 [x1] 4B00h: Baudrate 19200 [x1] 9600h: Baudrate 38400 [x1]
300225	00E0h	1	Parity	UINT16	1h: No Parity [x1] 2h: Even Parity [x1] 3h: Odd Parity [x1]
* Not available in RSBT40 unit					

Device Status

Read only mode (function 04h):

Modicon Address	Physical Address	Length (words)	Description	Data Format	Notes [Scaling Factor]
400061	003Ch	1	Status of alarm relay*	UINT16	0000h: Alarm relay is OFF 0001h: Alarm relay is ON
400062	003Dh	1	Status of top of ramp (TOR) relay*	UINT16	0000h: TOR relay is OFF 0001h: TOR relay is ON
400074	0049h	1	Soft starter status	UINT16	0001h: IDLE 0002h: Bypass 0003h: Alarm 0004h: Recovery
* Not available in RSBT40 unit					

Control

Read only mode (function 04h):

Modicon Address	Physical Address	Length (words)	Description	Data Format	Notes [Scaling Factor]
400032	001Fh	1	Control Input Status - Modbus	UINT16	0000h: Modbus control OFF 0001h: Modbus control ON
400078	004Dh	1	Control Input Status - A1, A2	UINT16	0000h: A1, A2 control OFF 0001h: A1, A2 control ON
400079	004Eh	1	Control Mode	UINT16	0000h: A1, A2 control mode 0001h: Modbus control mode
400066	0041h	1	Force Refresh Signal mode	UINT16	0000h : OFF 0001h: ON
400068	0043h	1	Refresh Interval (s)	UINT16	Sets the interval during which the refresh signal has to be refreshed.

Write only mode (function 06h):

Modicon Address	Physical Address	Length (words)	Description	Data Format	Notes [Scaling Factor]
300185	00B8h	1	Set the Control Mode	UINT16	0000h: A1, A2 control mode 0001h: Modbus control mode
300177	00B0h	1	Start/Stop Device	UINT16	0000h: Switch OFF 0001h: Switch ON
300193	00C0h	1	Soft Alarm Reset	UINT16	0001h: Resetting of alarms
300122	0079h	1	Force Refresh Signal mode	UINT16	Enable or Disable the refresh/heartbeat function 0000h: OFF 0001h: ON
300123	007Ah	1	Refresh Interval (s)	UINT16	Range: 0001h to 001Eh

Modicon Address	Physical Address	Length (words)	Description	Data Format	Notes [Scaling Factor]
300067	0042h	1	Force Refresh Signal (Heartbeat Signal)	UINT16	0001h: To send refresh signal. If refresh signal is Enabled, this register has to be written to within every refresh interval otherwise the RSBx unit will switch OFF output.

Delays

Read only mode (function 04h):

Modicon Address	Physical Address	Length (words)	Description	Data Format	Notes [Scaling Factor]
400063	003Eh	1	Minimum Stop to Start Delay (s)	UINT16	To read Stop to Start Delay [x1]
400075	004Ah	1	Minimum Start to Start Delay (s)	UINT16	To read Start to Start Delay [x1]
400064	003Fh	1	Time from Last Start	UINT16	To read Time from Last Start [x1]

Write only mode (function 06h):

Modicon Address	Physical Address	Length (words)	Description	Data Format	Notes [Scaling Factor]
300201	00C8h	1	Minimum Stop to Start Delay (s)	UINT16	Range: 0000h to 04B0h [x1]
300209	00D0h	1	Minimum Start to Start Delay (s)	UINT16	Range: 003Ch to 0258h [x1]

Protection Settings

Read only mode (function 04h):

Modicon Address	Physical Address	Length (words)	Description	Data Format	Notes [Scaling Factor]
400073	0048h	1	Supply Voltage Unbalance (%)	UINT16	To read Supply Voltage Unbalance [x1]
400026	0019h	1	Over Voltage Alarm (V)	UINT16	To read Over Voltage [x10]
400027	001Ah	1	Under Voltage Alarm (V)	UINT16	To read Under Voltage [x10]
400030	001Dh	1	I _{MAX} (Current Limit) (A _{rms})	UINT16	To read I _{MAX} (Current Limit) [x10]
400076	004Bh	1	Auto-Adapt	UINT16	To read Auto-Adapt Mode [x1]

Write only mode (function 06h):

Modicon Address	Physical Address	Length (words)	Description	Data Format	Notes [Scaling Factor]
300121	0078h	1	Supply Voltage Unbalance (%)	UINT16	Range: 0004h to 0014h [x1] ¹ Range: 0002h to 0050h [x1] ²
300129	0080h	1	Over Voltage Alarm (V)	UINT16	Range: 05DCh to 12C0h [x10] ¹ Range: 03E8h to 1770h [x10] ²
300173	0088h	1	Under Voltage Alarm (V)	UINT16	Range: 05DCh to 12C0h [x10] ¹ Range: 03E8h to 1770h [x10] ²

Modicon Address	Physical Address	Length (words)	Description	Data Format	Notes [Scaling Factor]
300161	00A0h	1	I_{MAX} (Current Limit) (A_{rms})	UINT16	Range: 0064h to xxxh [x1] ¹ xxxh: 0190h (16A version) 0384h (25A version) 0514h (32A version) Range: 0005h to xxxh [x1] ² xxxh: 0785h (55A version) 0992h (70A version) 0CFDh (95A version)
300217	00D8h	1	Auto-Adapt	UINT16	0000h: Auto-Adapt is OFF 0001h: Auto-Adapt is ON
1: Range for RSBT40 unit					
2: Range for RSBT48 unit					

History File

The history file allows the user to download a series of data related to the last 32 starts done by the device.

Read only mode (function 04h):

Modicon Address	Physical Address	Length (words)	Description	Data Format	Notes [Scaling Factor]
400177	00B0h	64	Start 1 to Start 4	UINT16	Data of the first set of 4 starts present in history
400185	00B8h	64	Start 5 to Start 8	UINT16	Data of the second set of 4 starts present in history
400193	00C0h	64	Start 9 to Start 12	UINT16	Data of the third set of 4 starts present in history
400201	00C8h	64	Start 13 to Start 16	UINT16	Data of the fourth set of 4 starts present in history
400209	00D0h	64	Start 17 to Start 20	UINT16	Data of the fifth set of 4 starts present in history
400217	00D8h	64	Start 21 to Start 24	UINT16	Data of the sixth set of 4 starts present in history
400225	00E0h	64	Start 25 to Start 28	UINT16	Data of the seventh set of 4 starts present in history
400233	00E8h	64	Starts 29 to Start 32	UINT16	Data of the eighth set of 4 starts present in history

Instantaneous Variables

Read only mode (function 04h):

Modicon Address	Physical Address	Length (words)	Description	Data Format	Notes [Scaling Factor]
400014	000Dh	1	V L1-L3	UINT16	Line voltage (L1-L3) [X10]
400015	000Eh	1	V L2-L3	UINT16	Line voltage (L2-L3) [X10]
400016	000Fh	1	V L1-L2	UINT16	Line voltage (L1-L2) [X10]
400018	0011h	1	V T1-T3	UINT16	Terminal voltage (T1-T3) [X10]
400019	0012h	1	V T2-T3	UINT16	Terminal voltage (T2-T3) [X10]
400020	0013h	1	V T1-T2	UINT16	Terminal voltage (T1-T2) [X10]
400021	0014h	1	A L1*	UINT16	Line current (L1) [X10]
400022	0015h	1	A L2*	UINT16	Line current (L2) [X10]
400023	0016h	1	A L3	UINT16	Line current (L3) [X10]
400024	0017h	1	Hz	UINT16	Supply frequency [X10]
400034	0021h	2	W Total	UINT32	Total instantaneous power [x1]
400035	0022h	2	VA Total	UINT32	Instantaneous apparent power [X1]
400036	0023h	1	PF Total	UINT16	Power factor [X100]
400037	0024h	2	kWh	UINT32	Instantaneous power consumption [x1]

* Not available in RSBT40 unit

Counters

Read only mode (function 04h):

Modicon Address	Physical Address	Length (words)	Description	Data Format	Notes [Scaling Factor]
400042	0029h	1	Number of starts	UINT16	Readout of the number of starts performed [X1]
400045	002Ch	1	Overflow of number of starts counter	UINT16	Readout of counter of number of starts when starts > 65,535

Chapter 6 Examples

6.1 Changing the communication parameters

The following example shows how the user can change the communication parameters of the RSBT unit.

Step 1: Go to the *Settings* window.

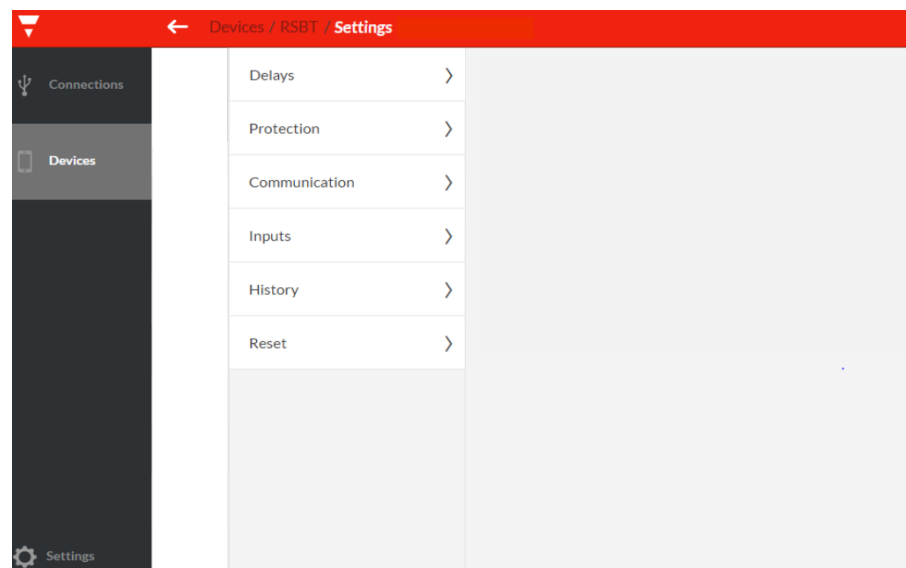

Step 2: Click on the *Communication* settings.

Device Address	<input type="text" value="1"/>
RS485 baud rate (bit/s)	<input type="text" value="9600"/>
RS485 parity	<input type="text" value="No parity"/>
<input type="button" value="Save"/>	

Step 3: Change the communication parameters as desired.



The communication parameters become effective only when the RSBT unit is turned OFF and ON.

6.2 Start/Stop through Modbus

The following example shows how the user can start and stop the RSBT unit through Modbus.

Step 1: Go to the *Settings* window.

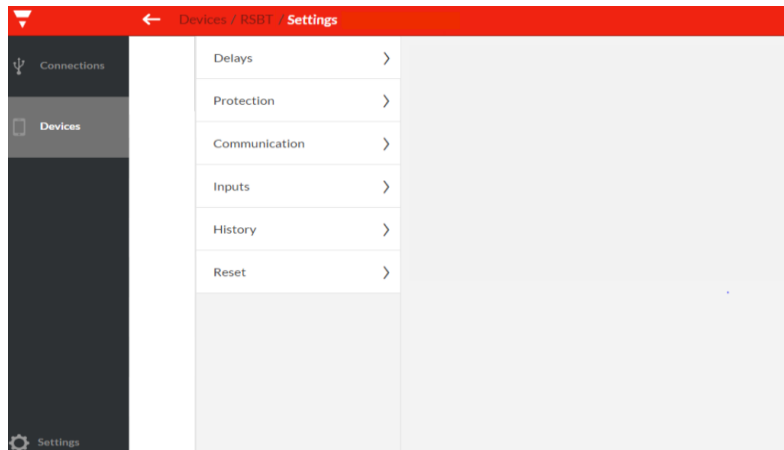

Step 2: Click on the *Inputs* settings, set the *Control Mode* to *Modbus Mode* and click save.

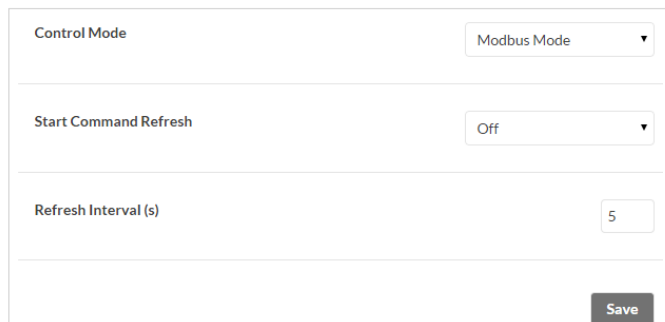

Step 3: Go to the *Dashboard* window and start the load by clicking on the on/off button.

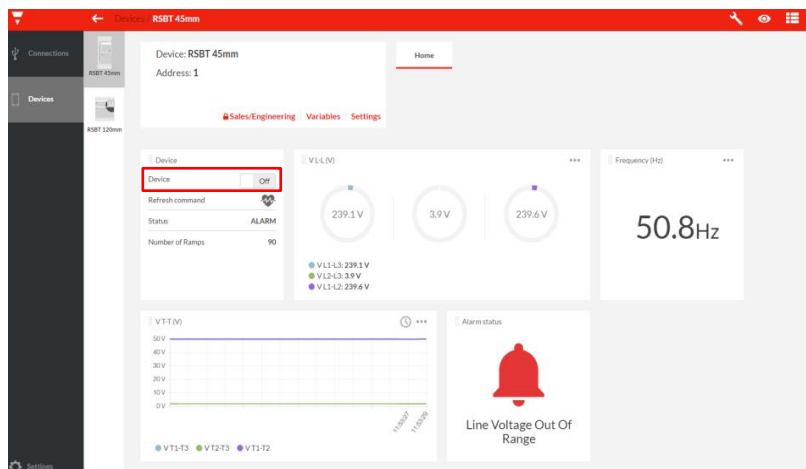

Step 4: Click the on/off button to stop the load.

6.3 Start/Stop using Force Refresh Signal

The following example shows how the user can start and stop the RSBT unit using force refresh signal.

Step 1: Go to the *Settings* window.

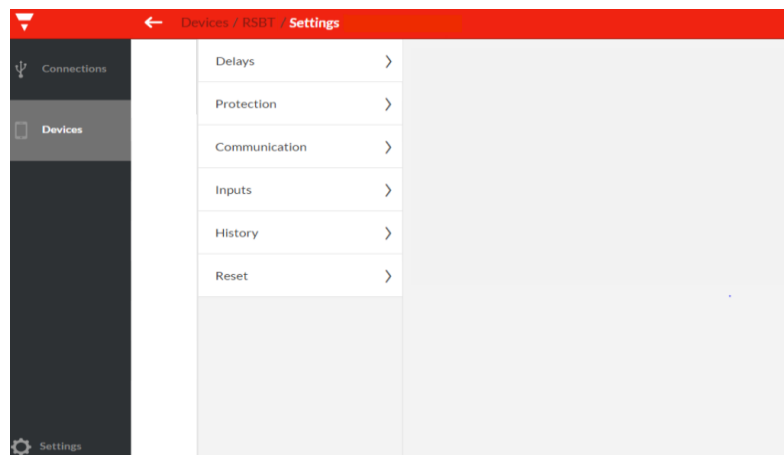

Step 2: Click on the *Inputs* settings, set the *Control Mode* to *Modbus Mode*, enable the *Start Command Refresh*, set the *Refresh Interval* and click save.

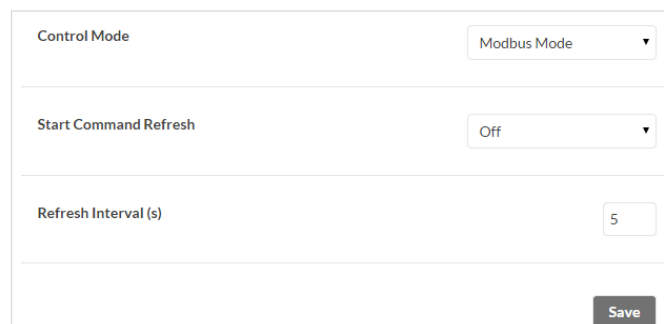

Step 3: Go to the *Dashboard* window and start the load by clicking on the on/off button.

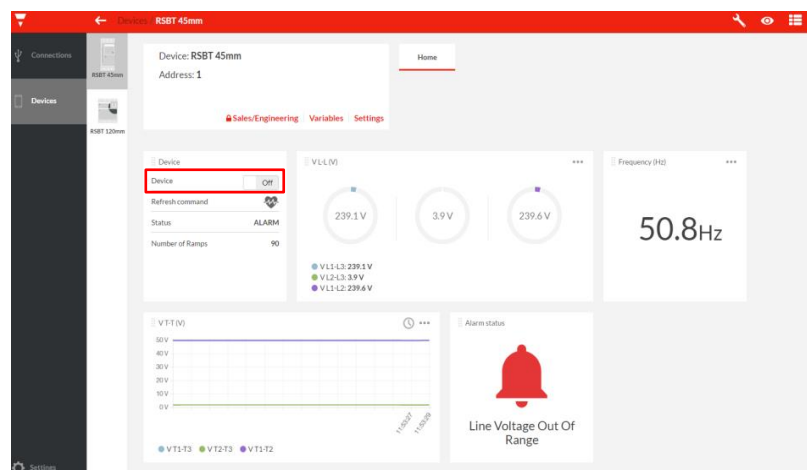

Step4: During the *Refresh Interval*, click on the *Refresh Command* button so that the load remains on.

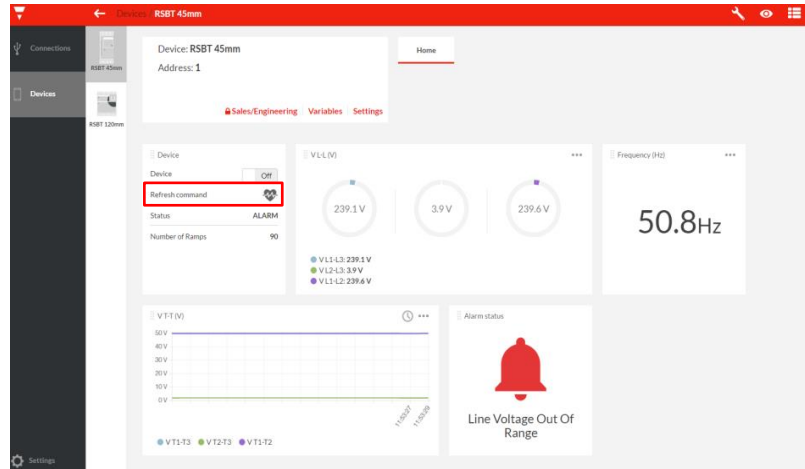

Step 5: Do not click on the *Refresh Command* button when you want to stop the load.