

# RGS..U, RGS..UDIN



## 1-Phase, 17.5mm solid state relays 'U' type connection



### Description

Aim of this solid state switching device is to switch heater loads and motor loads frequently. The range offers solutions up to 30 AAC in 17.5 mm width.

Output connections are provided via a box clamp. Input connections are via a screw connection having a captivated washer allowing for safe looping. Options with integrated heatsink are available in the RGC range.

The RGS...DIN provides an option for DIN mounting of the RGS series with a rating of 10 AAC @ 40°C.

Specifications are at a surrounding temperature of 25°C unless otherwise specified.

### Benefits

- **Panel space savings.** Product width of only 17.5 mm giving up to 60% space savings compared to the standard hockey puck platform.
- **Less maintenance costs.** Wire bonding technology reduces thermal and mechanical stresses of the output chips resulting in a larger number of operational cycles compared to other assembly technologies.
- **Low machine downtime.** Integrated overvoltage protection prevents the solid state relay from breaking down due to uncontrolled transients that may occur on the lines.
- **Cost effective protection co-ordination.** The high  $I^2t$  specification permits easy Type 2 protection co-ordination with B-type Miniature Circuit Breakers.
- **Fast wiring.** Power connections are equipped with terminals that can handle cables up to 25 mm<sup>2</sup> / AWG3 cables.
- **Accommodates UL508A requirements for Industrial Control Panels.** All models carry a 100 kArms Short Circuit Current Rating.

### Applications

Plastic injection machines, Extrusion machines, Blow moulding machines, Thermoformers, Dryers, Electrical ovens, Fryers, Shrink tunnels, Air handling units, Sterilisation equipment, Climatic chambers, Ovens and furnaces.

### Main features

- Zero cross or Instant on switching AC solid state relay
- Ratings up to 660 VAC, 30AAC
- Up to 1800 A<sup>2</sup>s for  $I^2t$
- Control voltages: 4-32 VDC, 20-275 VAC (24-190 VDC)
- Integrated overvoltage protection with varistor

**Order code**

**RGS1**  **60**  **30KGU** 

 Enter the code option instead of . Refer to selection guide section for valid part numbers.

Code	Option	Description	Comments
<b>R</b>	-	Solid State Relay (RG)	
<b>G</b>	-		
<b>S</b>	-	Without integrated heatsink	
<b>1</b>	-	1-pole switching	
<input type="checkbox"/>	<b>A</b>	Switching mode: Zero Cross (ZC)	
	<b>B</b>	Switching mode: Instant ON (IO)	
<b>60</b>		Rated voltage: 42-660 VAC, 1200 Vp	
<input type="checkbox"/>	<b>D</b>	Control voltage: 4-32 VDC	
	<b>A</b>	Control voltage: 20-275 VAC, 24-190 VDC	
<b>20</b>	-	Rated current: 20 AAC	Available with DIN rail mount accessory only
<b>30</b>	-	Rated current: 30 AAC	
<b>K</b>	-	Screw connection for control terminals	
<b>G</b>	-	Box clamp connection for power terminals	
<b>U</b>	-	Contact configuration	
<input type="checkbox"/>	-		Single packaging
	<b>HT<sup>1</sup></b>	Thermal pad	Option
	<b>DIN<sup>1</sup></b>	Din rail mount	Option
	<b>X40</b>	Bulk packaging of 40 pcs.	Option

1. Add suffix 'HT' to RGS part number for RGS with attached thermal pad. Add suffix 'DIN' to RGS part number for DIN rail mountable RGS.



## Selection guide - RGS..

Rated voltage, Blocking voltage	Switching mode	Control voltage	Maximum rated operational current
			30 AAC (1800 A <sup>2</sup> s)
600 VAC, 1200 Vp	Zero Cross (ZC)	4 - 32 VDC	RGS1A60D30KGU
		20-275 VAC, 24-190 VDC	RGS1A60A30KGU
	Instant ON (IO)	4 - 32 VDC	RGS1B60D30KGU

## Selection guide - RGS..DIN (RGS for DIN Rail Mounting)

Rated voltage, Blocking voltage	Switching mode	Control voltage	Maximum rated operational current
			10 AAC (525 A <sup>2</sup> s)
600 VAC, 1200 Vp	Zero Cross (ZC)	4 - 32 VDC	RGS1A60D20KGUDIN

KGU: input terminals = screw, output terminals = box clamp

## Carlo Gavazzi compatible components

Description	Component code	Notes
Screw kits	SRWKITM5X30MM	- RGS Screw kit for mounting to heatsink - Torx T20, size M5 x 30 mm - Packing qty: 20 pcs
Thermal pad	RGHT	Pack of 10 thermal pads size of 34.6 x 14mm
RG DIN clip	RGS1DIN	Din clip accessory
Heatsinks	RHS	Heatsinks and accessories

## Carlo Gavazzi further reading

Information	Where to find it	Notes
Datasheet	<a href="https://gavazziautomation.com/images/PIM/DATASHEET/ENG/rgc_u.pdf">https://gavazziautomation.com/images/PIM/DATASHEET/ENG/rgc_u.pdf</a>	Solid state contactor, RGC with 'U' - type configuration
Datasheet	<a href="https://gavazziautomation.com/images/PIM/DATASHEET/ENG/rgs.pdf">https://gavazziautomation.com/images/PIM/DATASHEET/ENG/rgs.pdf</a>	Solid state relay, RGS (without heatsink), 'E' - type configuration
Datasheet	<a href="https://gavazziautomation.com/images/PIM/DATASHEET/ENG/SSR_Accessories.pdf">https://gavazziautomation.com/images/PIM/DATASHEET/ENG/SSR_Accessories.pdf</a>	Heatsink range overview
	<a href="https://gavazziautomation.com/nsc/hq/en/solid_state_relays">https://gavazziautomation.com/nsc/hq/en/solid_state_relays</a>	Online Heatsink selector tool

## Structure

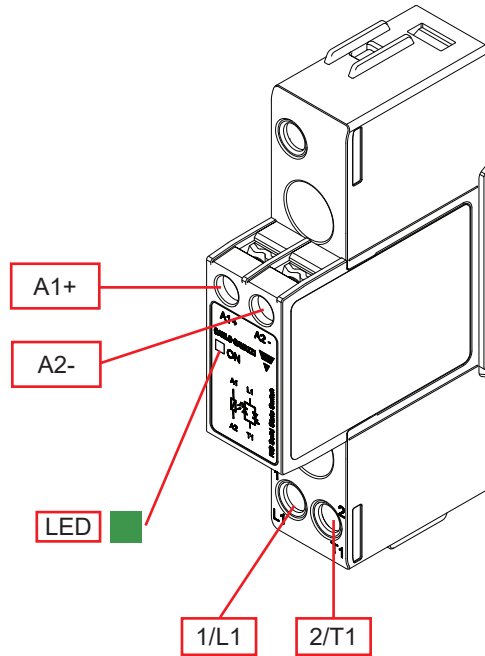

Element	Component	Function
1/L1	Power connections	Mains connections
2/T1	Power connections	Load connections
A1, A2	Control connection	Terminals for control voltage
Green LED	CONTROL indicator	Indicates presence of control voltage and supply voltage

## Features

### General data

<b>Material</b>	PA66 or PA6 (UL94 V0), RAL7035 850°C, 750°C/2s according to GWIT and GWFI requirements of EN 60335-1	
<b>Mounting</b>	Panel mount	
<b>Touch Protection</b>	IP20	
<b>Overvoltage Category</b>	III, 6 kV (1.2/50 $\mu$ s) rated impulse withstand voltage	
<b>Isolation</b>	Input and Output to Case Input to Output	4000 Vrms 4000 Vrms
<b>Weight</b>	RGS.. RGS...DIN	approx. 103g approx. 155g

## Performance

### Output Specifications

	RGS..U	RGS..UDIN
<b>Operational voltage range, Ue</b>	42-600 VAC +10%, -15% on max.	
<b>Blocking voltage</b>	1200 Vp	
<b>Max. operational current per pole<sup>2</sup>: AC-51 @ Ta=40°C</b>	30 AAC	10AAC <sup>4</sup>
<b>Max. operational current per pole<sup>2</sup>: AC-53a @ Ta=40°C</b>	8 AAC	-
<b>Operational frequency range</b>	45 to 65 Hz	
<b>Output protection</b>	Integrated varistor	
<b>Leakage current @ rated voltage</b>	3mAAC	
<b>Minimum operational current</b>	250 mACA	150 mACA
<b>Repetitive overload current (Motor rating) UL508: Ta=40°C, t<sub>ON</sub>=1 s, t<sub>OFF</sub>=9 s, 50 cycles</b>	84 AAC	-
<b>Non-repetitive surge current (I<sub>TSM</sub>), t=10 ms</b>	600 Ap	325 Ap
<b>I<sup>2</sup>t for fusing (t=10 ms), minimum</b>	1800 A <sup>2</sup> s	525 A <sup>2</sup> s
<b>No. of motor starts per hour<sup>2,3</sup> (x: 6, Tx:6s, F:50%) @ 40°C</b>	30	-
<b>Power factor</b>	>0.5 at rated voltage	-
<b>Critical dV/dt (@Tj init = 40°C)</b>	1000 V/ $\mu$ s	

2. Refer to Heatsink selection table

3. Overload profile for AC-53a: Ie: AC-53a: x-Tx: F-S,

where Ie = nominal current (AC-53a AAC), x = overload current factor, Tx = duration of overload current (s), F = duty cycle (%), S = number of starts per hour. Example; 8A: AC-53a: 6 - 6 : 50 - 30 = max. 30 starts for the RGS..30 with an overload profile of 48A for 6 seconds with a duty cycle of 50%

4. Refer to Derating vs. Spacing Curves

### Motor Ratings<sup>2</sup>: HP (UL508) / kW (EN/IEC 60947-4-2) @ 40°C

	115 VAC	230 VAC	400 VAC	480 VAC	600 VAC
<b>RGS..30</b>	3/4HP / 0.37kW	2HP / 1.1kW	3HP / 1.5kW	5HP / 2.2kW	5HP / 3.7kW

## Inputs

	RGS..D..	RGS..A..
Control voltage range (A1, A2) <sup>5</sup>	4 - 32 VDC	20-275 VAC, 24 (-10%) -190 VDC
Pick-up voltage	3.8 VDC	-
Drop-out voltage	1.0 VDC	5 VAC/DC
Maximum reverse voltage	32 VDC	-
Maximum response time, RGS1A	0.5 cycle + 500 $\mu$ s @ 24 VDC	2 cycles @ 230 VAC/110 VDC
Maximum response time, RGS1B	350 $\mu$ s @ 24 VDC	N/A
Response time drop-out	0.5 cycle + 500 $\mu$ s @ 24VDC	0.5 cycle + 40 ms @ 230 VAC/ 110 VDC
Input current @ 40°C	See diagrams below	

5: DC control to be supplied by a Class 2 power source according to UL1310

## Input current vs. input voltage

RGS..D..

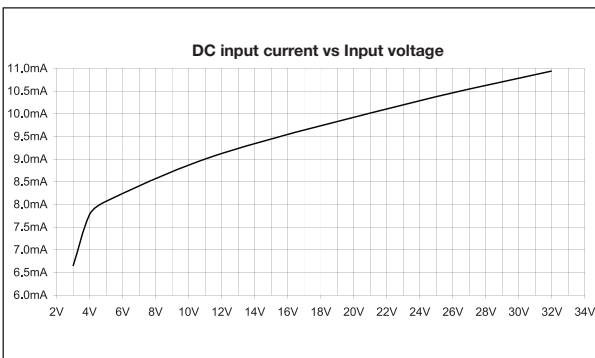

RGS..A..

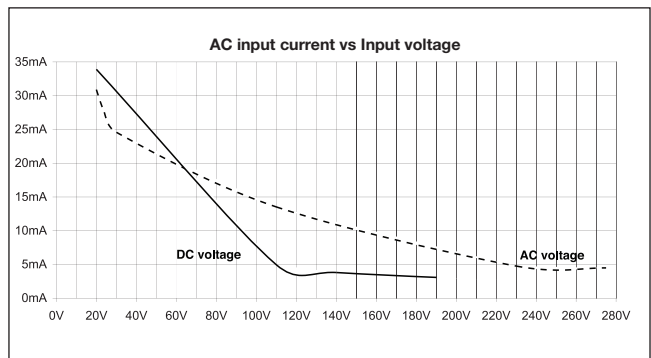

## Output power dissipation

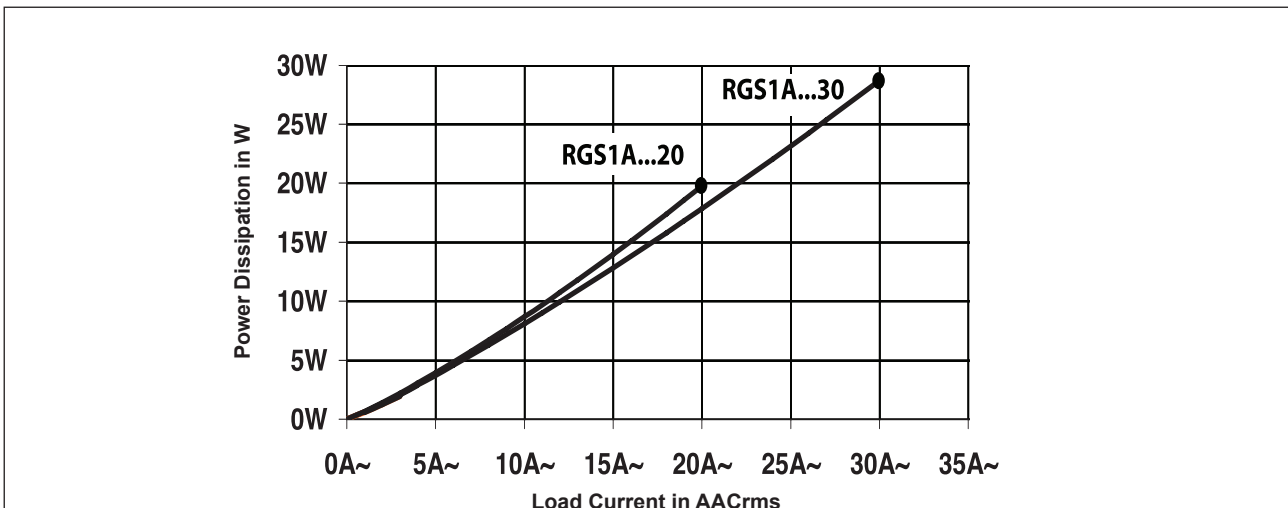

**Derating vs. spacing curves for RGS...DIN**

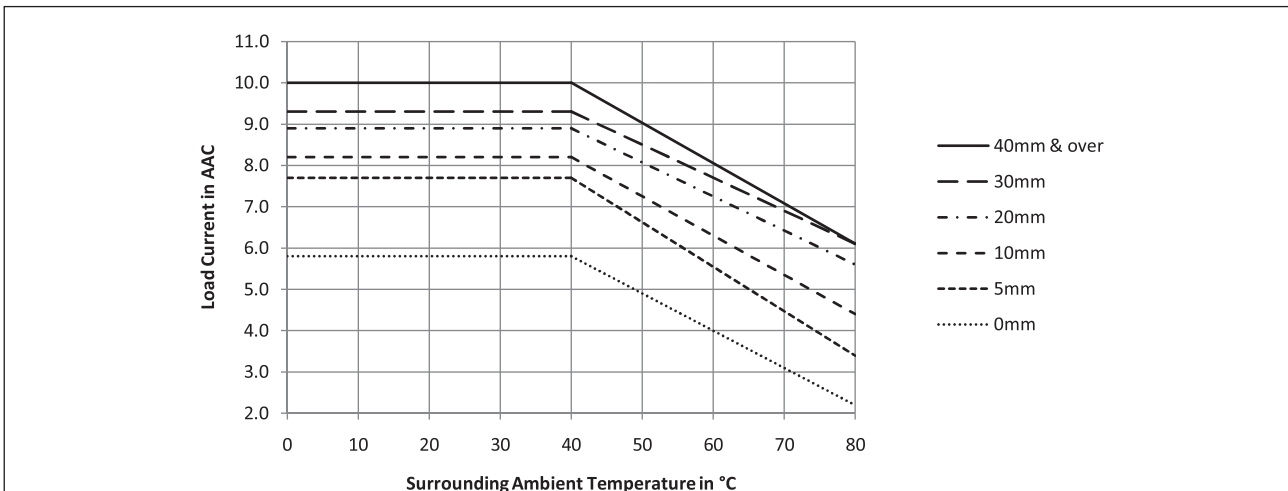

**Heatsink selection**

Thermal resistance [°C/W] of RGS1..30

Load current [A]	Surrounding ambient temperature [°C]						
	20	30	40	50	60	70	80
32.0	2.6	2.3	2.0	1.6	1.3	0.98	0.66
29.0	3.0	2.6	2.2	1.9	1.5	1.1	0.74
25.5	3.4	3.0	2.6	2.1	1.7	1.3	0.86
22.5	4.0	3.5	3.0	2.5	2.0	1.5	1.0
19.0	4.8	4.2	3.6	3.0	2.4	1.8	1.2
16.0	5.9	5.2	4.5	3.7	3.0	2.2	1.5
13.0	7.7	6.7	5.8	4.8	3.8	2.9	1.9
9.5	10.7	9.3	8.0	6.7	5.3	4.0	2.7
6.5	16.9	14.8	12.7	10.6	8.5	6.3	4.2
3.2	-	-	-	-	18.4	13.8	9.2

Thermal resistance [°C/W] of RGS1..30..HT

Load current [A]	Surrounding ambient temperature [°C]						
	20	30	40	50	60	70	80
32.0	2.3	2.0	1.6	1.3	0.98	0.65	0.33
29.0	2.8	2.4	2.0	1.6	1.3	0.9	0.52
25.5	3.4	2.9	2.5	2.1	1.6	1.2	0.78
22.5	4.0	3.5	3.0	2.5	2.0	1.5	1.0
19.0	4.8	4.2	3.6	3.0	2.4	1.8	1.2
16.0	5.9	5.2	4.5	3.7	3.0	2.2	1.5
13.0	7.7	6.7	5.8	4.8	3.8	2.9	1.9
9.5	10.7	9.3	8.0	6.7	5.3	4.0	2.7
6.5	16.9	14.8	12.7	10.6	8.5	6.3	4.2
3.2	-	-	-	-	18.4	13.8	9.2





**Thermal data**

	RGS..30..
Max. junction temperature	125°C
Junction to case thermal resistance, $R_{thjc}$	<0.3°C/W
Case to heatsink thermal resistance, $R_{thcs}^6$	<0.25°C/W
Case to heatsink thermal resistance (RGS..HT), $R_{thcs\_HT}^7$	<0.85°C/W

6: Thermal resistance case to heatsink values are applicable upon application of a fine layer of silicon based thermal paste HTS02S from Electrolube between SSR and heatsink.

7: Thermal resistance case to heatsink values for RGS..HT are applicable for the RGHT thermal pad that is pre-attached from the factory to the RGS.

### Compatibility and conformance

<b>Approvals</b>	    
<b>Standards compliance</b>	LVD: EN/IEC 60947-4-2, EN/IEC 60947-4-3 EMCD: EN/IEC 60947-4-3 cURus: UL508 Recognised (E172877), NMFT2, NMFT8 CSA: C22.2 No.14, (204075) VDE: VDE0660-109
<b>UL short circuit current rating</b>	100k Arms (refer to short circuit current section, Type 1 – UL508)

Electromagnetic compatibility (EMC) - Immunity	
<b>Electrostatic discharge (ESD)</b>	EN/IEC 61000-4-2 8 kV air discharge, 4 kV contact (PC1)
<b>Radiated radio frequency</b>	EN/IEC 61000-4-3 10 V/m, from 80 MHz to 1 GHz (PC1) 10 V/m, from 1.4 to 2 GHz (PC1) 10 V/m, from 2 to 2.7 GHz (PC1)
<b>Electrical fast transient (burst)</b>	EN/IEC 61000-4-4 Output: 2 kV, 5 kHz (PC1) Input: 1 kV, 5 kHz (PC1)
<b>Conducted radio frequency</b>	EN/IEC 61000-4-6 10 V/m, from 0.15 to 80 MHz (PC1)
<b>Electrical surge</b>	EN/IEC 61000-4-5 Output, line to line: 1 kV (PC1) Output, line to earth: 2 kV (PC1) Input, line to line: 1 kV (PC2) Input, line to earth: 2 kV (PC2)
<b>Voltage dips</b>	EN/IEC 61000-4-11 0% for 0.5, 1 cycle (PC2) 40% for 10 cycles (PC2) 70% for 25 cycles (PC2) 80% for 250 cycles (PC2)
<b>Voltage interruptions</b>	EN/IEC 61000-4-11 0% for 5000 ms (PC2)

Electromagnetic compatibility (EMC) - Emissions	
<b>Radio interference field emission (radiated)</b>	EN/IEC 55011 Class A: from 30 to 1000 MHz
<b>Radio interference voltage emissions (conducted)</b>	EN/IEC 55011 Class A: from 0.15 to 30 MHz (External filter may be required - refer to Filtering section)



## Additional conformance to railway standards

<b>Applicable to variants</b>	RGS..U
<b>Additional conformance specific to railway applications</b>	EN 50155 EN 45545-2 EN 50121-3-2
<b>Hazardous level conformance according to EN 45545-2</b>	HL1, HL2 for requirement R23 HL1 for requirement R22
<b>Operating temperature class according to EN 50155</b>	OT3 (-25 °C to +70 °C )
<b>Vibration and shock</b>	EN 61373 Category 1, Class B
<b>Additional EMC conformance</b>	according to EN 50121-3-2
<b>Radiated radio frequency immunity</b>	EN/IEC 61000-4-3 20 V/m, from 80 MHz to 1 GHz (PC1) 10 V/m, from 1.4 to 2 GHz (PC1) 5 V/m, from 2 to 2.7 GHz (PC1) 3V/m, 5.1 - 6 GHz (PC1)
<b>Power quality measurement</b>	EN/IEC 61000-4-30 50 Hz - 2 kHz, <8% THD (PASS)

Note:

- Control input lines must be installed together to maintain products' susceptibility to Radio Frequency interference.
- Use of AC solid state relays may, according to the application and the load current, cause conducted radio interferences. Use of mains filters may be necessary for cases where the user must meet E.M.C requirements. The capacitor values given inside the filtering specification tables should be taken only as indications, the filter attenuation will depend on the final application.
- Performance Criteria 1 (PC1): No degradation of performance or loss of function is allowed when the product is operated as intended.
- Performance Criteria 2 (PC2): During the test, degradation of performance or partial loss of function is allowed. However when the test is complete the product should return operating as intended by itself.
- Performance Criteria 3 (PC3): Temporary loss of function is allowed, provided the function can be restored by manual operation of the controls.

## Filter connection diagram

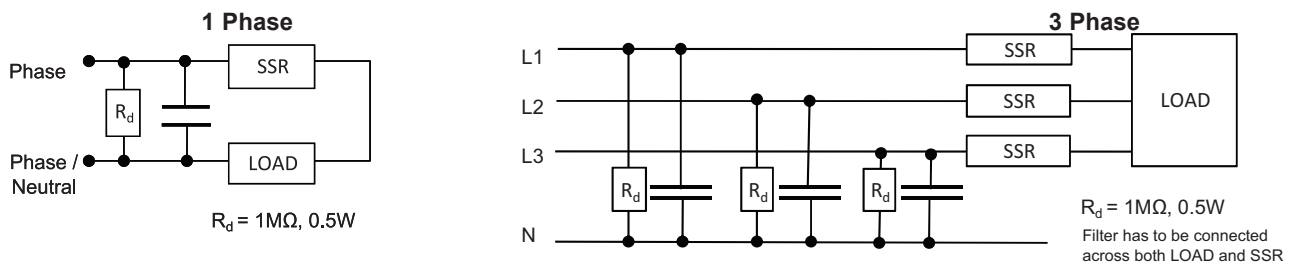

## Filtering

Part number	Suggested filter for EN 55011 Class A compliance	Maximum heater current [AAC]
RGS1...20	100 nF / 760 V / X1	10 AAC
RGS1...30	330 nF / 760 V / X1	30 AAC

## Environmental specifications

<b>Operating temperature</b>	-40°C to +80°C (-40°F to +176°F)
<b>Storage temperature</b>	-40 to +100 °C (-40 to +212 °F)
<b>Relative humidity</b>	95% non-condensing @ 40°C
<b>Pollution degree</b>	2
<b>Installation altitude</b>	0-1000 m. Above 1000 m derate linearly by 1% of FLC per 100 m up to a maximum of 2000 m
<b>Vibration resistance</b>	2g / axis (2-100Hz, IEC 60068-2-6, EN 50155, EN 61373)
<b>Impact resistance</b>	15/11 g/ms (EN50155, EN61373)
<b>EU RoHS compliant</b>	Yes
<b>China RoHS</b>	

The declaration in this section is prepared in compliance with People's Republic of China Electronic Industry Standard SJ/T11364-2014: Marking for the Restricted Use of Hazardous Substances in Electronic and Electrical Products.

Part Name	Toxic or Harardous Substances and Elements					
	Lead (Pb)	Mercury (Hg)	Cadmium (Cd)	Hexavalent Chromium (Cr(VI))	Polybrominated biphenyls (PBB)	Polybrominated diphenyl ethers (PBDE)
<b>Power Unit Assembly</b>	x	O	O	O	O	O

O: Indicates that said hazardous substance contained in homogeneous materials for this part are below the limit requirement of GB/T 26572.

X: Indicates that said hazardous substance contained in one of the homogeneous materials used for this part is above the limit requirement of GB/T 26572.

这份申明根据中华人民共和国电子工业标准 SJ/T11364-2014：标注在电子电气产品中限定使用的有害物质

零件名称	有毒或有害物质与元素					
	铅 (Pb)	汞 (Hg)	镉 (Cd)	六价铬 (Cr(VI))	多溴化联苯 (PBB)	多溴联苯醚 (PBDE)
功率单元	x	O	O	O	O	O

O:此零件所有材料中含有的该有害物低于GB/T 26572的限定。

X: 此零件某种材料中含有的该有害物高于GB/T 26572的限定。



**Short circuit protection**

**Protection Co-ordination, Type 1 vs Type 2:**

Type 1 protection implies that after a short circuit, the device under test will no longer be in a functioning state. In Type 2 co-ordination the device under test will still be functional after the short circuit. In both cases, however the short circuit has to be interrupted. The fuse between enclosure and supply shall not open. The door or cover of the enclosure shall not be blown open. There shall be no damage to conductors or terminals and the conductors shall not separate from terminals. there shall be no breakage or cracking of insulating bases to the extent that the integrity of the mounting of live parts is impaired. Discharge of parts or any risk of fire shall not occur.

The product variants listed in the table hereunder are suitable for use on a circuit capable of delivering not more than 100,000 Arms Symmetrical Amperes, 600 Volts maximum when protected by fuses. Tests at 100,000 A were performed with Class J fuses, fast acting; please refer to the table below for maximum allowed ampere rating of the fuse. Use fuses only.

Tests with Class J fuses are representative of Class CC fuses.

Protection co-ordination Type 1 according to UL 508				
Part No.	Prospective short circuit current [kArms]	Max fuse size [A]	Class	Voltage [VAC]
RGS...20	100	10 15	J CC	Max. 600
RGS...30		30	J or CC	

Protection co-ordination (IEC/EN 60947-4-2/ -4-3)						
Part No.	Prospective short circuit current [kArms]	Ferraz Shawmut (Mersen)		Siba		Voltage [VAC]
		Max fuse size [A]	Part number	Max fuse size [A]	Part number	
RGS...20	100	32	6.9xx CP URD 22x58 /32	32	50 142 06 32	Max. 600
RGS...30		40	A70QS40-4	32	50 142 06 32	

Protection co-ordination Type 2 with Miniature Circuit Breakers (M.C.B.s)				
Solid State Relay type	ABB Model no. for Z - type M. C. B. (rated current)	ABB Model no. for B - type M. C. B. (rated current)	Wire cross sectional area [mm <sup>2</sup> ]	Minimum length of Cu wire conductor [m] <sup>8</sup>
RGS..20 (525 A <sup>2</sup> s)	1-pole S201 - Z4 (4A) S201 - Z6 UC (6A)	S201 - B2 (2A) S201 - B2 (2A)	1.0	21.0
			1.0	21.0
			1.5	31.5
RGS..30 (1800 A <sup>2</sup> s)	1-pole S201 - Z10 (10A)	S201 - B4 (4 A)	1.0	7.6
			1.5	11.4
			2.5	19.0
	S201 - Z16 (16A)	S201 - B6 (6 A)	1.0	5.2
			1.5	7.8
	S201 - Z20 (20A)	S201 - B10 (10 A)	2.5	13.0
			4.0	20.8
	S201 - Z25 (25A)	S201 - B13 (13 A)	1.5	12.6
			2.5	21.0
	2-pole S202 - Z25 (25A)	S202 - B13 (13 A)	2.5	25.0
4.0			40.0	
S202 - Z25 (25A)	S202 - B13 (13 A)	2.5	19.0	
		4.0	30.4	

8. Between MCB and Load (including return path which goes back to the mains)

Note: A prospective current of 6 kA and a 230 / 400 V power supply is assumed for the above suggested specifications. For cables with different cross section than those mentioned above please consult Carlo Gavazzi's Technical Support Group.

S201 models refer to 1-pole M.C.B., S202 models refer to 2-poles M.C.B.

## Dimensions

### RGS...KGU

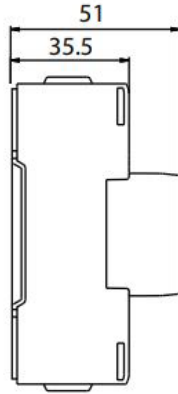
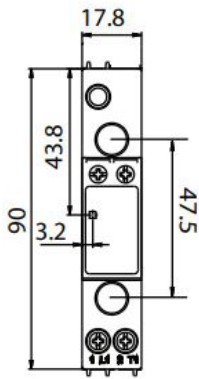

### RGS...KGUDIN

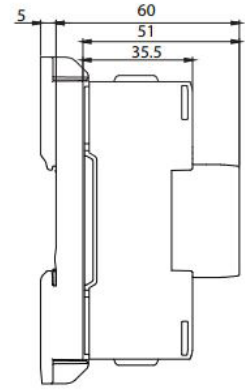
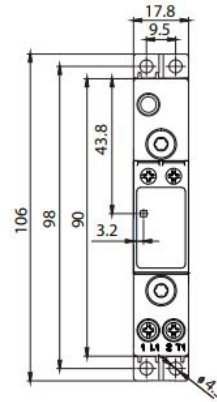

Housing width tolerance +0.5mm, -0mm as per DIN 43880. All other tolerances +/- 0.5mm.  
Dimensions in mm.

## Terminal Layout

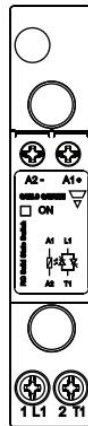

1/L1: Supply connection  
2/T1: Load connection  
A1 (+): Positive control signal  
A2 (-): Control ground

# Connection Diagram

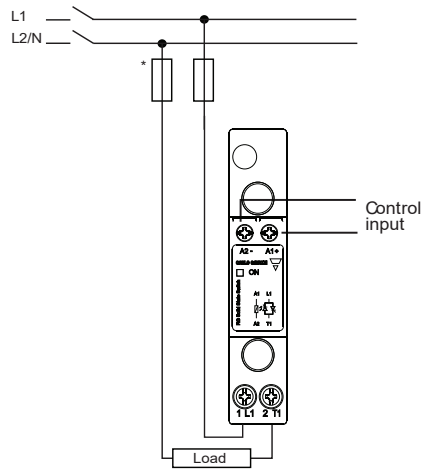

\* depends on system requirements

## Functional diagram

### DC control

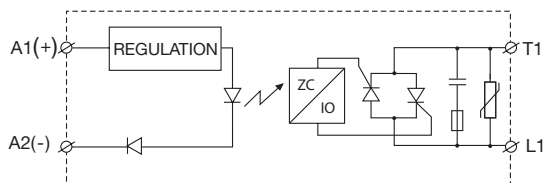

### AC control

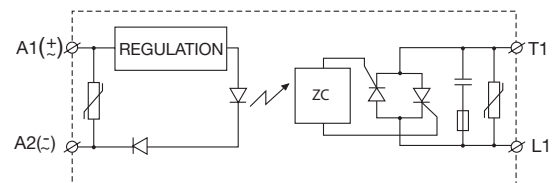

## Mounting instructions for RGS..KGU

Thermal stress will reduce the lifetime of the SSR. Therefore it is necessary to select the appropriate heatsinks, taking into account the surrounding temperature, load current and the duty cycle.

A fine layer of thermally conductive silicone paste must be evenly applied to the back of the SSR. RGS should be mounted on the heatsink with two M5 x 30mm screws (**SRWKITM5X30MM**).

Gradually tighten each screw (alternating between the two) until both are tightened with a torque of 0.75 Nm. Then tighten both screws to their final mounting torque of 1.5 Nm.

In case of a thermal pad attached to the back of the SSR, no thermal paste is required. The RGS is gradually tightened (alternating between the 2 screws) to a maximum torque of 1.5Nm.

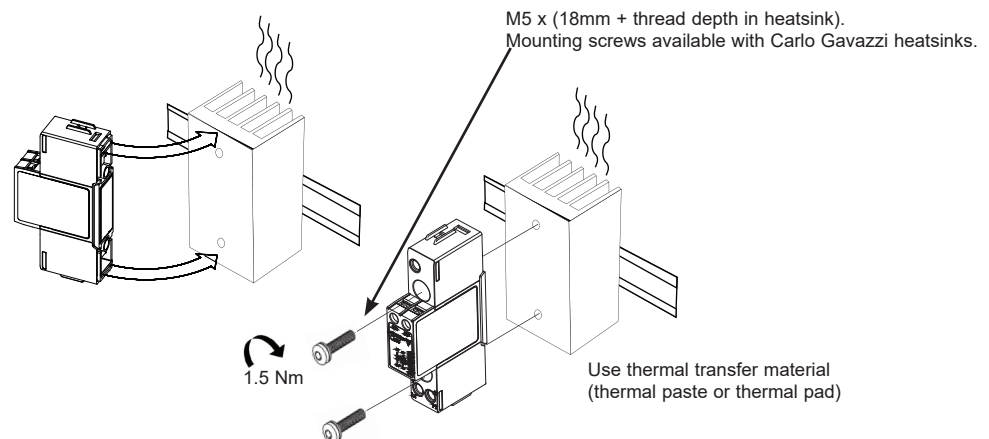

**Mounting Instructions for RGS1DIN to RGS**

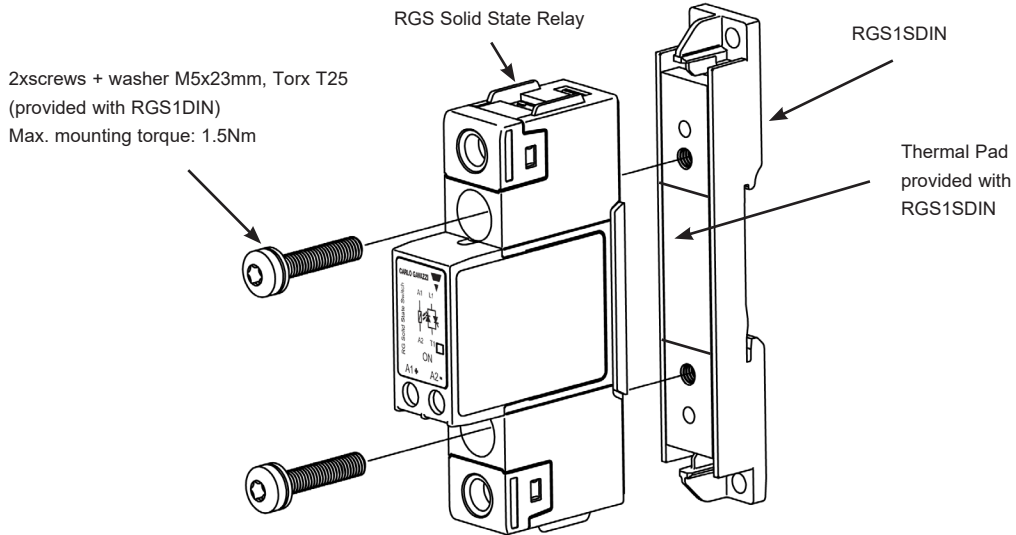

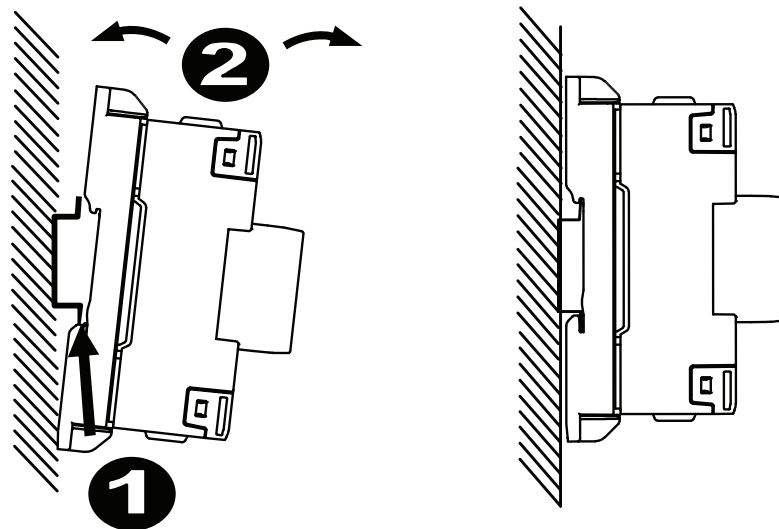

**RGS..DIN installation instructions**

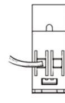

## Connection Specifications

Power connection	
Terminal	1/L1, 2/T1
Conductors	Use 75°C copper (Cu) conductors
	
Stripping length	12 mm
Connection type	M3.5 screw with box clamp
Rigid (solid & stranded) UL/CSA rated data	1x 1..6 mm <sup>2</sup> 1x 18..10 AWG
Flexible with end sleeve	1x 0.5..2.5 mm <sup>2</sup> 1x 20..14 AWG
Flexible without end sleeve	1x 1..4 mm <sup>2</sup> 1x 18..12 AWG
Torque specifications	Posidrive bit 1 UL: 1 Nm (8.85 lb-in) IEC: 0.9 - 1.1 Nm (8.0 - 9.7 lb-in)

Control connection		
Terminals	A1(+), A2(-)	
Conductors	Use 60/75°C copper (Cu) conductors	
	 	
Stripping length	8 mm	
Connection type	M3 screw with captivated washer	
Rigid (solid & stranded) UL/CSA rated data	2x 0.5 - 2.5 mm <sup>2</sup> 2x 18 - 12 AWG	1x 0.5 - 2.5 mm <sup>2</sup> 1x 18 - 12 AWG
Flexible with end sleeve	2x 0.5 - 2.5 mm <sup>2</sup> 2x 18 - 12 AWG	1x 0.5 - 2.5 mm <sup>2</sup> 1x 18 - 12 AWG
Torque specification	Posidrive 1 UL: 0.5 Nm (4.4 lb-in) IEC: 0.5-0.6 Nm (4.4-5.3 lb-in)	

## Bulk packaging option



- Packing qty.: 40 pcs.
- Weight: 4.2 Kgs



COPYRIGHT ©2021

Content subject to change. Download the PDF: <https://gavazziautomation.com>